



GOLDTEX

I . N . D . U . S . T . R . I . E . S

MANUFACTURER EXPORTER & IMPORTER OF SURGICAL, DENTAL & MAINCURE INSTRUMENTS



Chairman



WELCOME TO GOLDTEX INDUSTRIES (PVT) LTD.

ASSALAM-O-ALEQUM !

We would like to introduce about our company,
Our experience in manufacturing of Surgical, Dental, Veterinary and Beauty Instruments has been built-up since 1973, systematically, uncompromisingly and precisely.

"**GOLDTEX** Industries" utilizes German technology and Japanese stainless steel to produce the high quality Surgical, Dental, Veterinary and Beauty instruments.

All **GOLDTEX** instruments are hand crafted and accessories have been carefully designed to meet the rigorous demand of the most discriminating healthcare professional throughout the world.

GOLDTEX Industries products are manufactured from the finest materials with an uncompromising concern for quality. Exhaustive inspection of every instrument by our factory trained quality control staff and we ensure strict compliance with our standards for performance and durability. The service and the **GOLDTEX** Industry's commitment to manufacturing excellence are backed by the industry's most extensive products warranties.

State of the art distribution combined with knowledgeable courteous staff guarantees that the service you receive will be as outstanding as the products we deliver. So, compare the quality performance, and most important value of **GOLDTEX** Industry's products to any other you can buy.

You will discover there's really no comparison at all, our products enjoy a reputation for advance design combined with skilled craftsmanship.

Thank you! Best Regards and hearing from you soon,

Syed Afzal Hasan Hashmi.

Chairman

GOLDTEX I.N.D.U.S.T.R.I.E.S

Surgical

PDF Catalogue





GOLDTEX

I . N . D . U . S . T . R . I . E . S

MANUFACTURER EXPORTER & IMPORTER OF SURGICAL, DENTAL & MAINCURE INSTRUMENTS



Chairman



Certifications

The company is ranked as having an International standing not only in its products but also in its processes. The certifications are listed below for customer viewing.

ISO 9001:2000

Quality management systems- Requirements

Certificate GB056406



The measurement number of

Goldtex Industries

19/552-Wazirpora

Sialkot, Pakistan



has been assessed and certified as meeting the requirements of

ISO 9001:2000

For the following activities

Manufacture and Export of Surgical Instruments, Dental Instruments, Scissors and Tungsten Carbide (TC) Surgical Instruments.

Further certifications regarding the scope of this certificate and the applicability of ISO 9001:2000 requirements may be obtained by consulting the organisation.

This certificate is valid from 03 February 2005 until 03 February 2008 Issue 1. Certified since 03 February 2005

Authorized by

P. Earl



SGS United Kingdom Ltd. Systems & Services Certification
Rosemary Business Park, Epsom Park, Cheshire. Ch45 3EN UK
T +44 (0)151 300 6000 F +44 (0)151 300 6000 www.sgs.com

SGS 9001-2 01 0303

Page 1 of 1



www.sgs.com



GOLDTEX

I . N . D . U . S . T . R . I . E . S

MANUFACTURER EXPORTER & IMPORTER OF SURGICAL, DENTAL & MAINCURE INSTRUMENTS



Chairman



Certifications

The company is ranked as having an International standing not only in its products but also in its processes. The certifications are listed below for customer viewing.

ISO 13485:2003

Medical devices quality management systems- Requirement for regulatory purposes

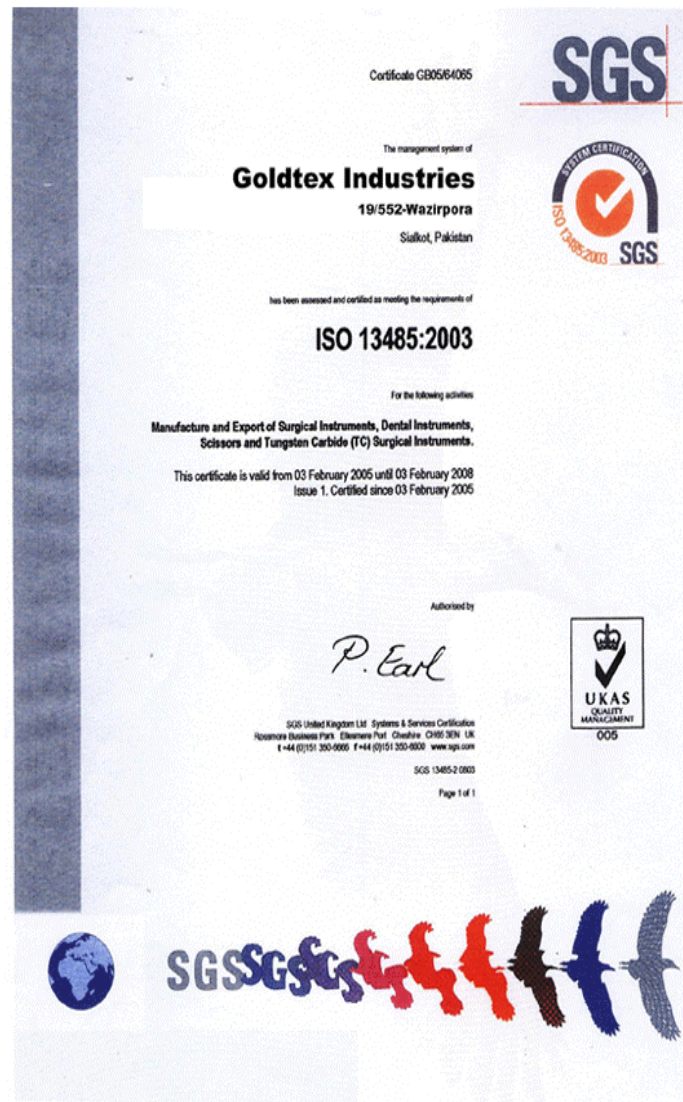



OPERATING SCISSORS



Str
 09-097 (18cm)
 09-098 (20cm)
 09-099 (23cm)
 09-100 (25cm)
 09-101 (28cm)
 09-102 (30cm)

Metzenbaum-Nelson
 09-097 to 09-102

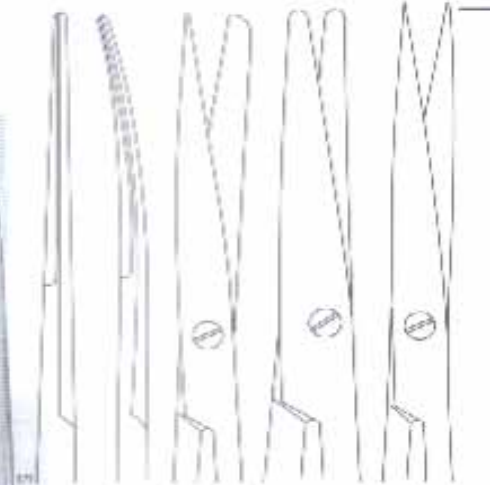
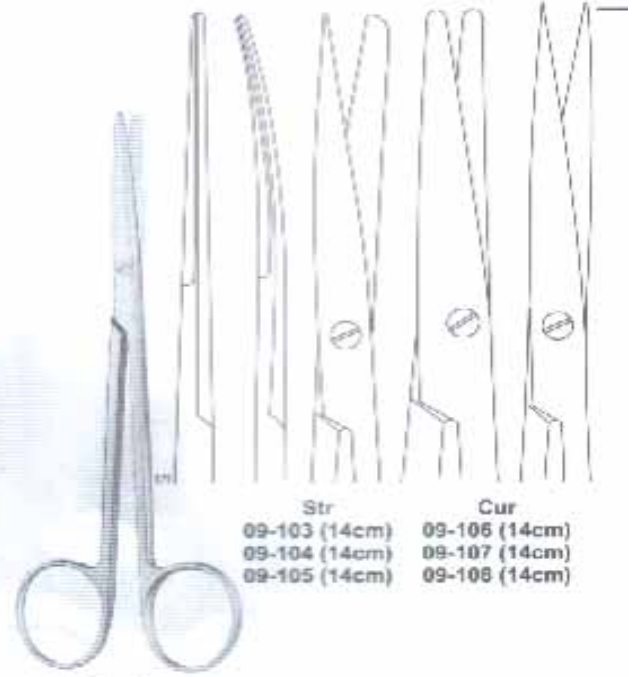

Str Cur
 09-103 (14cm) 09-106 (14cm)
 09-104 (14cm) 09-107 (14cm)
 09-105 (14cm) 09-108 (14cm)

Metzenbaum
 09-103 to 09-108



Str
 09-109 (18cm)
 09-110 (20cm)
 09-111 (23cm)
 09-112 (25cm)
 09-113 (28cm)
 09-114 (30cm)

Metzenbaum-Nelson
 09-109 to 09-114



Str
 09-115 (18cm)
 09-116 (20cm)
 09-117 (23cm)
 09-118 (25cm)
 09-119 (28cm)
 09-120 (30cm)

Metzenbaum-Nelson
 09-115 to 09-120

DISSECTING & FINE OPERATING SCISSORS



Kilner
(12cm)

Str
10-121

Cur
10-122

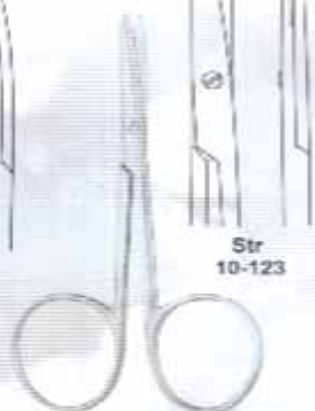

Lexer-Baby
(10cm)

Str
10-123

Cur
10-124

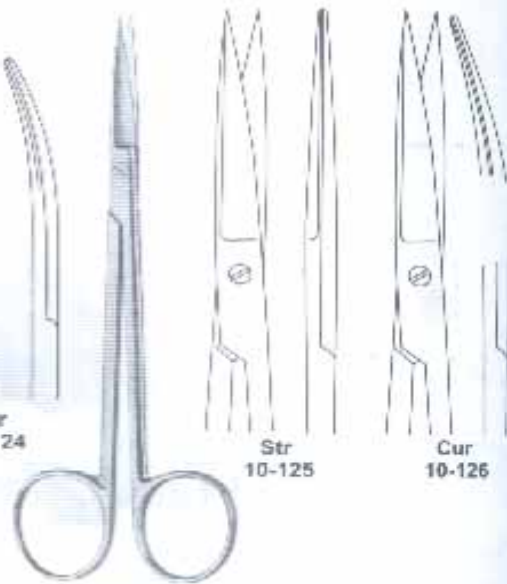

Joseph
(14cm)

Str
10-125

Cur
10-126



10-127 to 10-128
(11cm)

Str
10-127

Cur
10-128



Reynolds
10-129 to 10-132

Str
10-129(15cm)
10-130(18cm)

Cur
10-131(15cm)
10-132(18cm)

LIGATURE, WIRE CUTTING & GUM SCISSORS

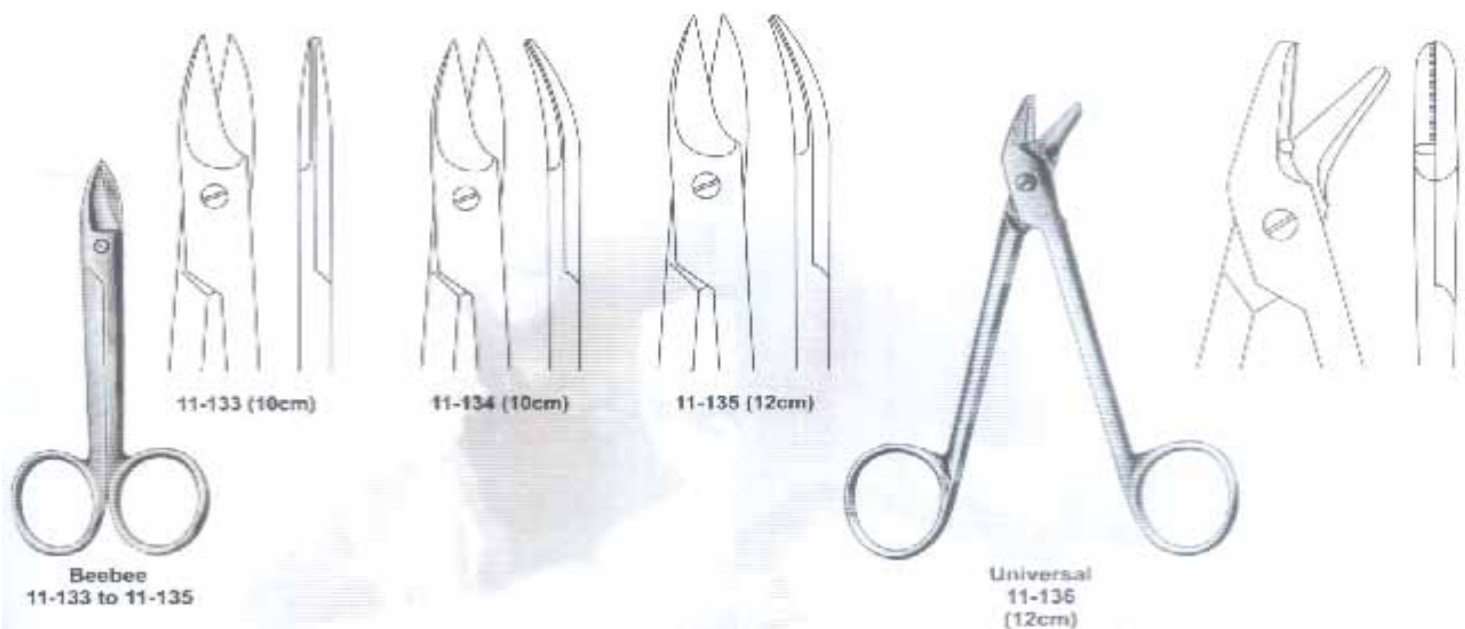

11-133 (10cm)

11-134 (10cm)

11-135 (12cm)

Universal
11-136
(12cm)

Beebee
11-133 to 11-135

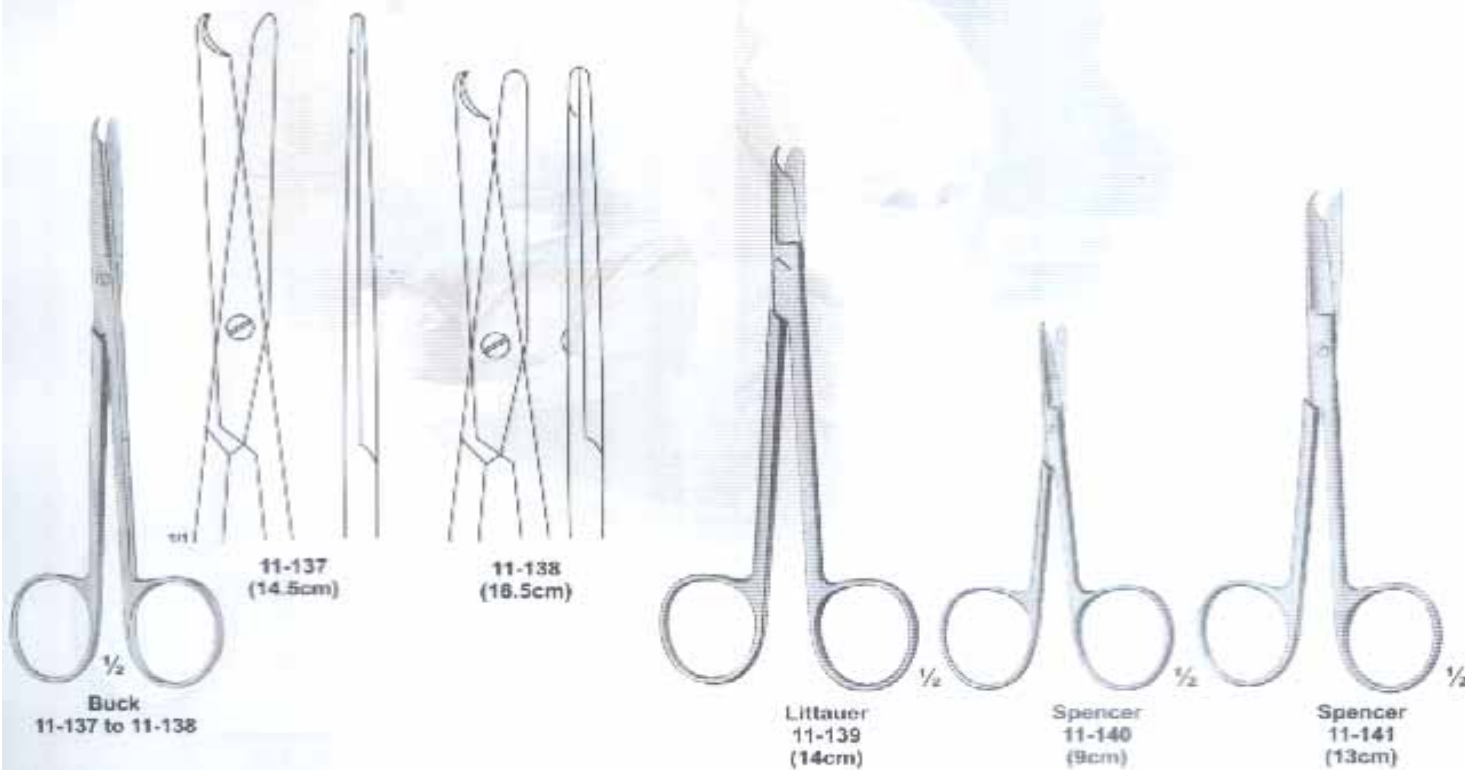

11-137
(14.5cm)

11-138
(16.5cm)

Littauer
11-139
(14cm)

Spencer
11-140
(9cm)

Spencer
11-141
(13cm)

Buck
11-137 to 11-138



UMBILICAL SCISSORS

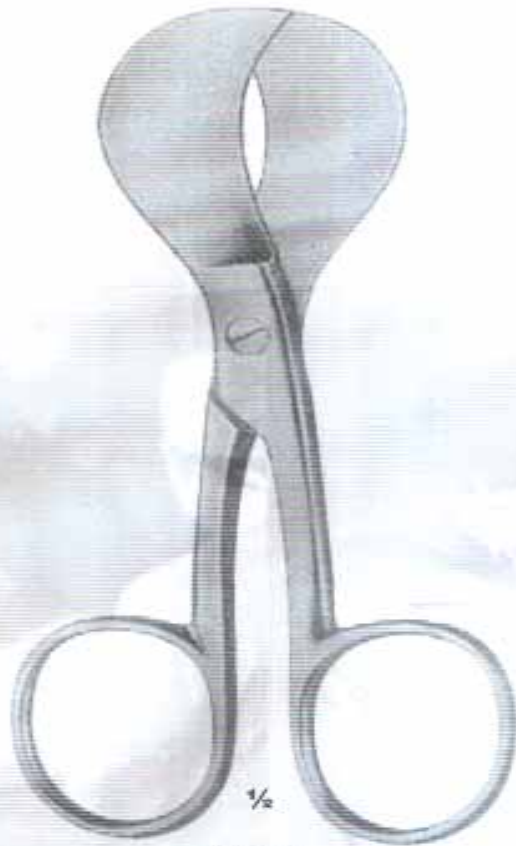

Mod. USA
12-143
(10.5cm)

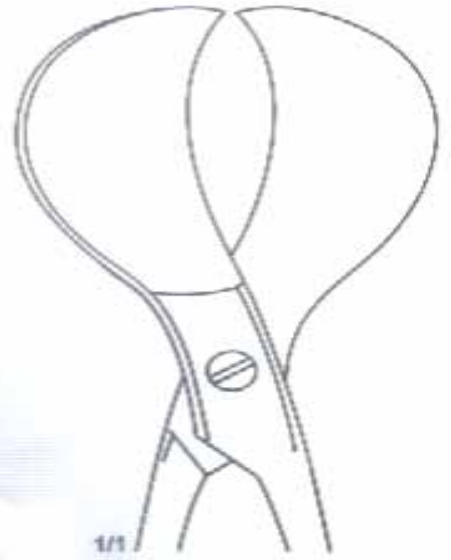

Busch
12-142
(16cm)

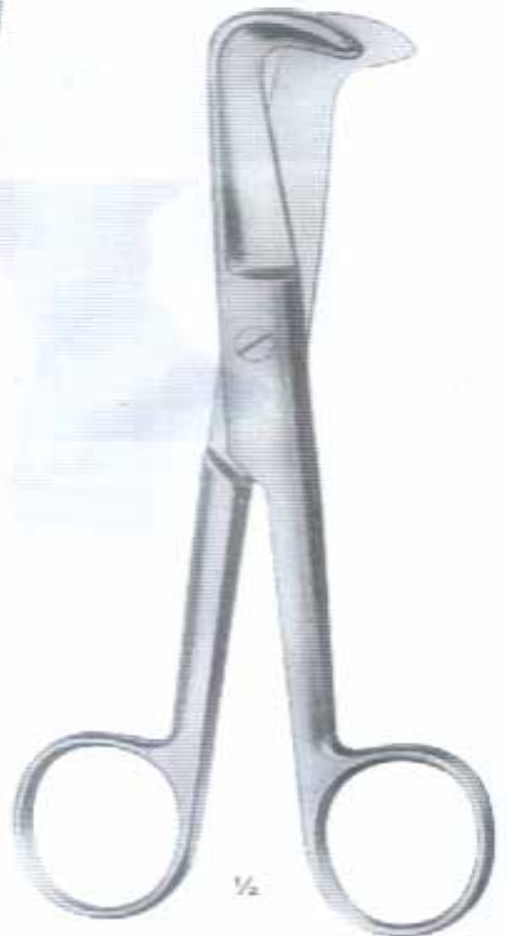

Schuhmacher
12-143/A
(15.5cm)

PLASTER SHEARS, BANDAGE & UTILITY SCISSORS



13-144
(20cm)



Lister
13-145 (9cm)
13-146 (14cm)
13-147 (18cm)
13-148 (20cm)



Utility
13-149 (15cm)
13-150 (18cm)

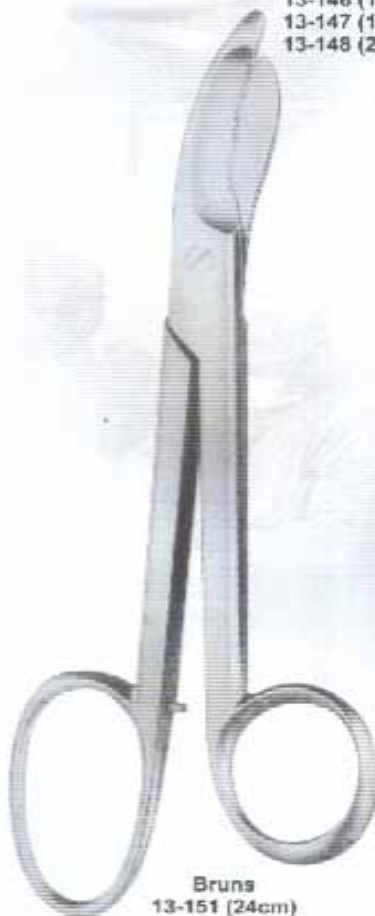

Brun's
13-151 (24cm)



Stille
13-152 (20cm)
13-153 (22cm)



MICRO & GUM SCISSORS



1/2

14-154 to 14-155



Str
14-154
(18.5cm)



Cur
14-155
(18.5cm)



1/2

Westcott
(14-156 to 14-157)



Str
14-156
(11.5cm)

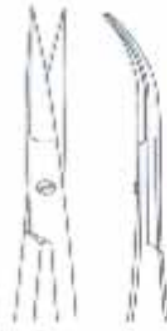

Cur
14-157
(11.5cm)



1/2

Neumann
14-158
(12.5cm)



1/2

Quinby
14-159
(12.5cm)



ARTERY FORCEPS



Halsted-Mosquito
15-160 to 15-167



15-160
(12.5cm)
15-181
(14cm)



15-162
(12.5cm)
15-163
(14cm)



15-164
(12.5cm)
15-165
(14cm)



15-166
(12.5cm)
15-167
(14cm)



Halsted-Mosquito
15-168 to 15-174



15-168
(16cm)
15-169
(18cm)



15-170
(16cm)
15-171
(18cm)



15-172
(16cm)
15-173
(18cm)



15-174
(16cm)
15-175
(18cm)



Mosquito
15-176 to 15-183



15-176
(10.5cm)
15-177
(12.5cm)



15-178
(10.5cm)
15-179
(12.5cm)



15-180
(10.5cm)
15-181
(12.5cm)



15-182
(10.5cm)
15-183
(12.5cm)



Crile
15-184 to 15-185



15-184
(14cm)



15-185
(14cm)



ARTERY FORCEPS



1/1

Spencer-Wells
16-186 to 16-195



16-186 (13cm)
16-187 (14cm)
16-188 (15cm)
16-189 (18cm)
16-190 (20cm)



16-191 (13cm)
16-192 (14cm)
16-193 (15cm)
16-194 (18cm)
16-195 (20cm)



Kelly
16-196 to 16-197
(14cm)



16-196



16-197

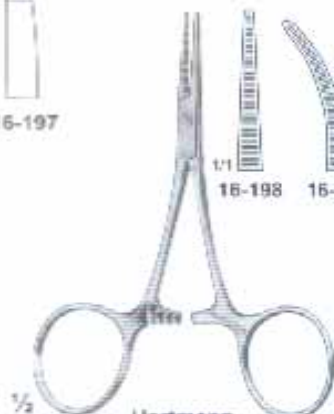

1/2

Hartmann
16-198 to 16-199
(10cm)



16-198



16-199



Baby-Mixter
16-100 to 16-101
(14cm)



16-100



16-101

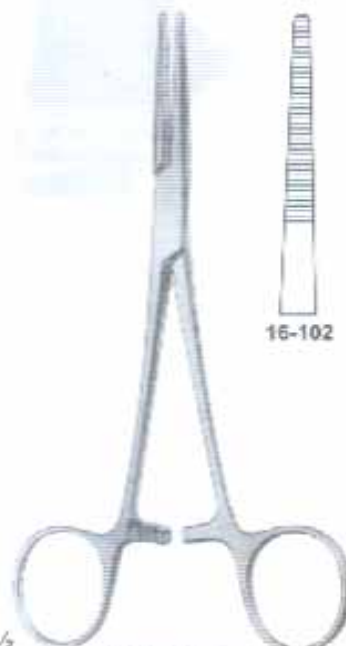

1/2

Kelly-Rankin
16-102 to 16-103
(16cm)



16-102



16-103

ARTERY FORCEPS

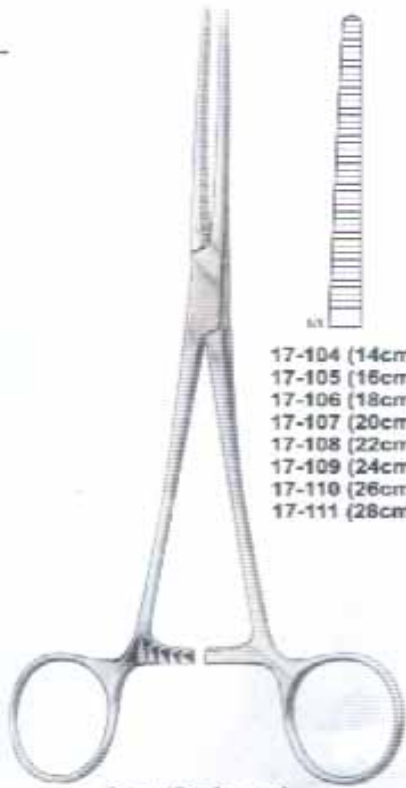

Pean (Rochester)
17-104 to 17-119

- | | |
|---------------|---------------|
| 17-104 (14cm) | 17-112 (14cm) |
| 17-105 (16cm) | 17-113 (16cm) |
| 17-106 (18cm) | 17-114 (18cm) |
| 17-107 (20cm) | 17-115 (20cm) |
| 17-108 (22cm) | 17-116 (22cm) |
| 17-109 (24cm) | 17-117 (24cm) |
| 17-110 (26cm) | 17-118 (26cm) |
| 17-111 (28cm) | 17-119 (28cm) |

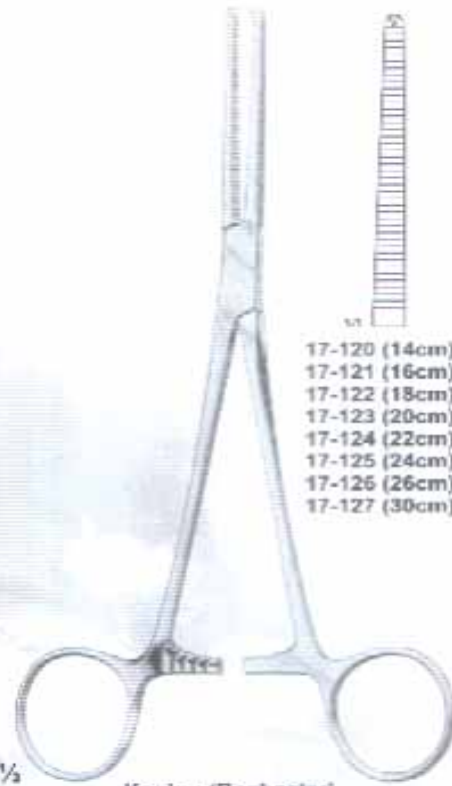

Kocher (Rochester)
17-120 to 17-144

- | | |
|---------------|---------------|
| 17-120 (14cm) | 17-128 (14cm) |
| 17-121 (16cm) | 17-129 (16cm) |
| 17-122 (18cm) | 17-130 (18cm) |
| 17-123 (20cm) | 17-131 (20cm) |
| 17-124 (22cm) | 17-132 (22cm) |
| 17-125 (24cm) | 17-133 (24cm) |
| 17-126 (26cm) | 17-134 (26cm) |
| 17-127 (30cm) | 17-135 (30cm) |

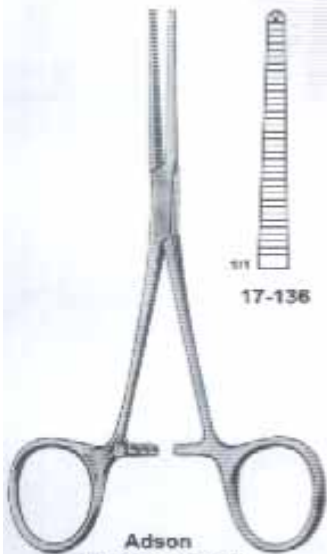

Adson
17-136 to 17-137
(18.5cm)

17-136

17-137

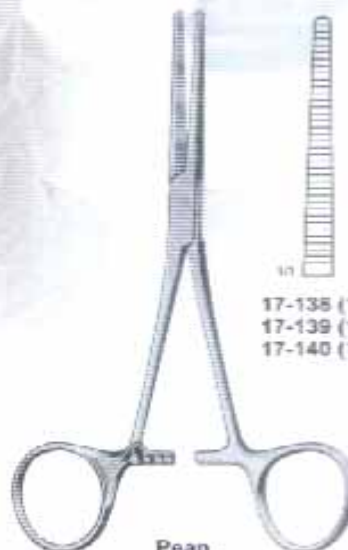

Pean
17-138 to 17-143

- | | |
|---------------|---------------|
| 17-138 (13cm) | 17-141 (13cm) |
| 17-139 (14cm) | 17-142 (14cm) |
| 17-140 (16cm) | 17-143 (16cm) |



ARTERY & HYSTERECTOMY FORCEPS



Hosemann
18-144 to 18-145



18-144
(21cm)



18-145
(21cm)



Haney
17-146 to 17-151



18-146
(19.5cm)



18-147
(21cm)



18-148
(23cm)



18-149
(19.5cm)



18-150
(21cm)



18-151
(23cm)



Phaneuf
18-152 to 18-153



18-152
(21.5cm)



18-153
(21.5cm)



Negus
18-154 to 18-155



18-154
(19cm)



18-155
(19cm)



TOWEL FORCEPS



Schaedel
19-156
(9cm)



Jones
19-157
(5cm)
19-158
(9cm)



Lorma
19-159
(10cm)
19-160
(13cm)

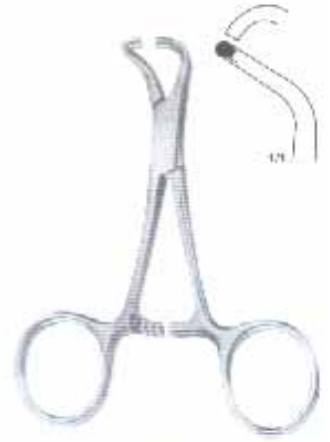

Tohoku
19-161
(10cm)
19-162
(13cm)



19-163
(11cm)
19-164
(13cm)



Backhaus
19-165 (8 cm)
19-166 (11cm)
19-167 (13cm)
19-168 (15cm)

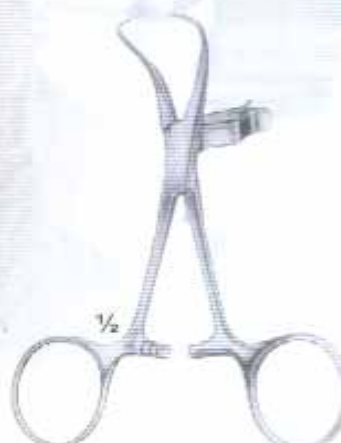

19-169
(11cm)



Roeder
19-170
(13cm)
19-171
(15cm)

TISSU & ORGAN HOLDING FORCEPS



4 : 5
20-175
(15cm)



20-175
(15cm)

20-175
(15cm)

20-175
(15cm)

20-175
(15cm)

20-175
(15cm)

20-175
(15cm)

20-175
(15cm)

20-175
(15cm)

20-175
(15cm)

20-175
(15cm)

20-175
(15cm)

20-175
(15cm)

20-175
(15cm)

5 : 6
20-176
(15cm)
20-177
(19cm)
20-178
(23cm)



20-176
(15cm)

20-177
(19cm)

20-178
(23cm)

20-178
(23cm)

20-178
(23cm)

20-178
(23cm)

20-178
(23cm)

20-178
(23cm)

20-178
(23cm)

20-178
(23cm)

20-178
(23cm)

20-178
(23cm)

20-178
(23cm)



TISSU & ORGAN HOLDING FORCEPS



Babcock
21-179 to 21-182



1/1
21-179
(16 mm)



21-180
(18 mm)



21-181
(20 mm)



21-182
(24 mm)

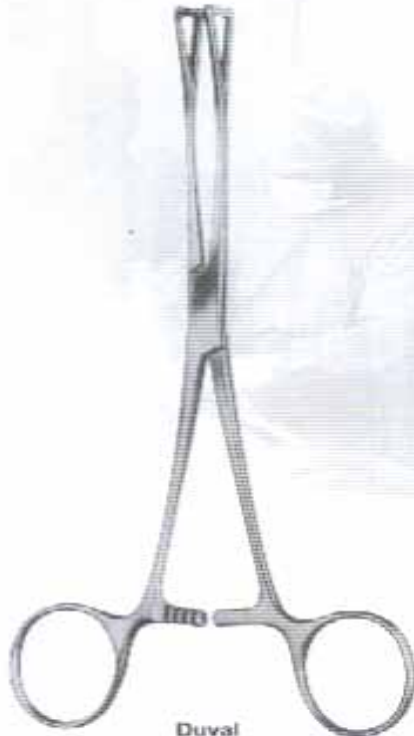

Duval
21-183 to 21-184



1/1
21-183
(20cm)



21-184
(23cm)



LAMINA SPREADERS

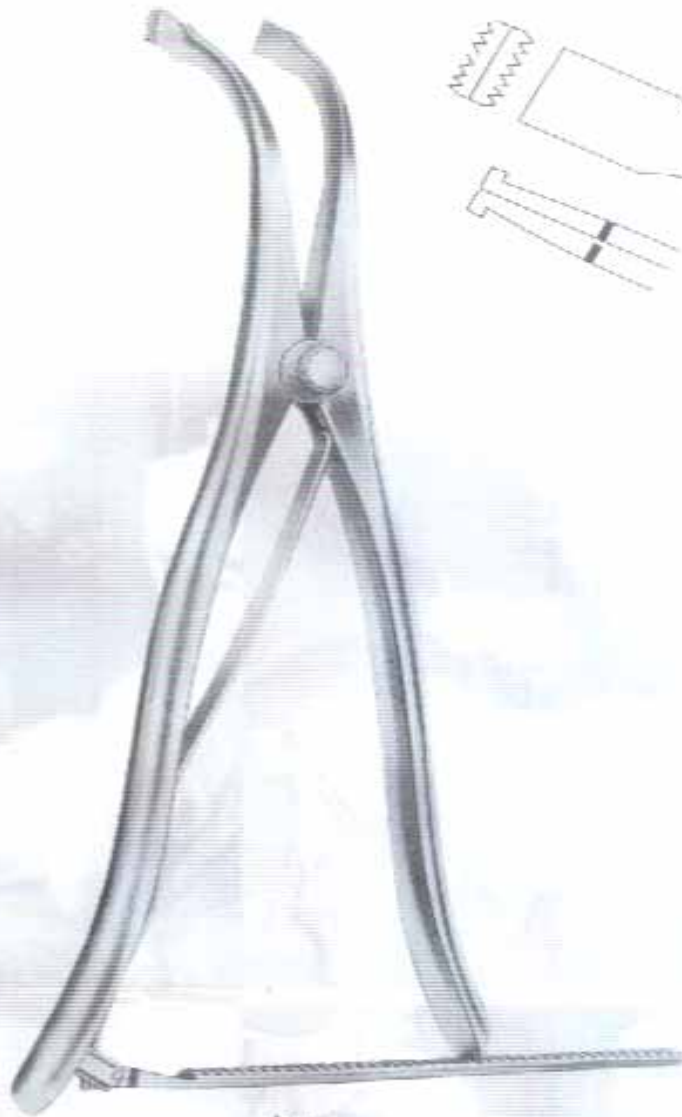

Inge
22-185
(27cm)

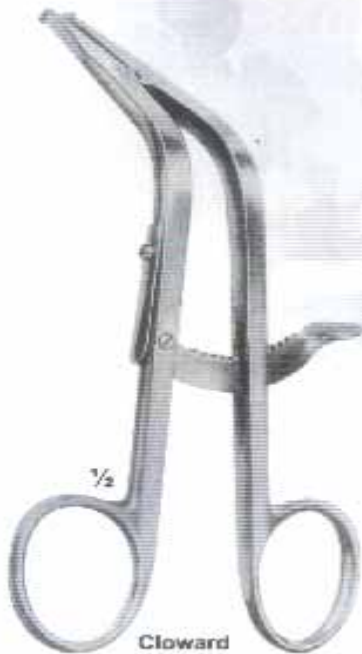
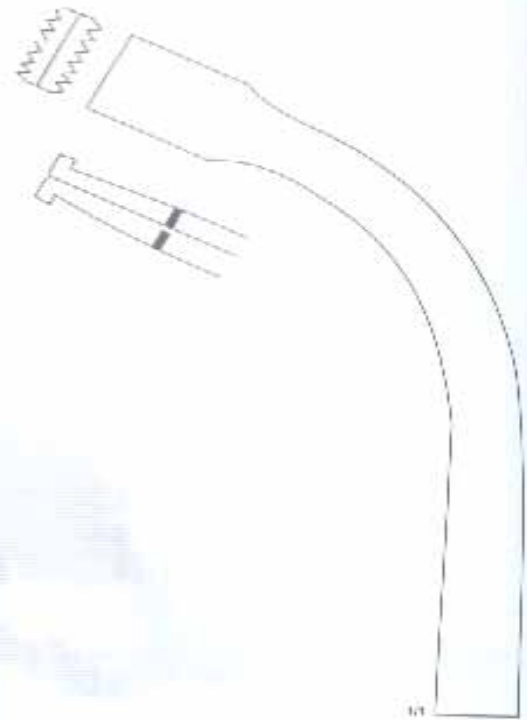

Cloward
22-186
(16cm)

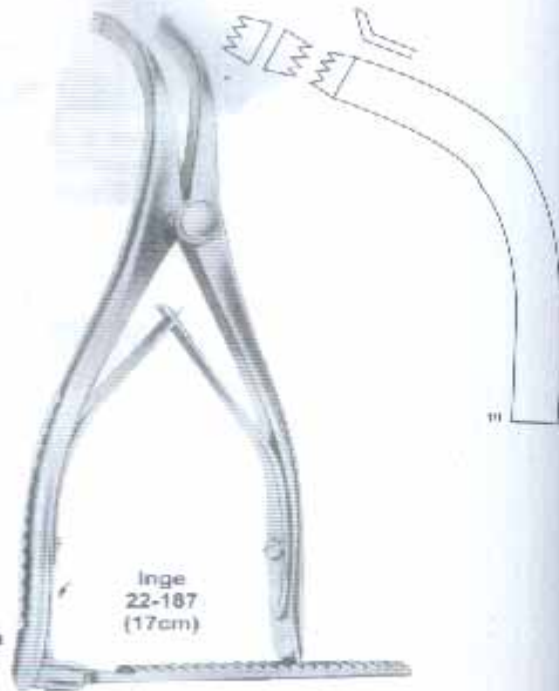

Inge
22-187
(17cm)

POLYPUS & SPONGE HOLDING FORCEPS



Foerster
23-188
(25cm)



23-188



23-188/A

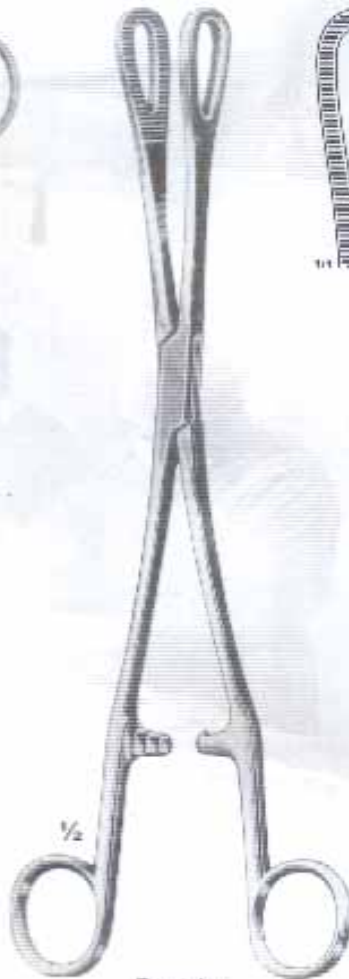

Rampley
23-189
(25cm)



Bozemann-Douglas
23-190
(26cm)

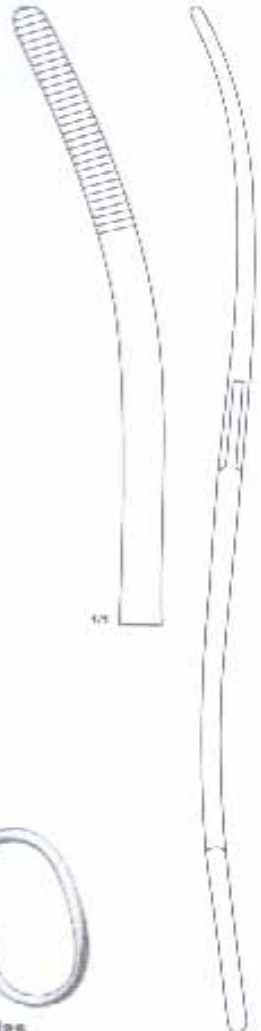



SPONGE HOLDING FORCEPS

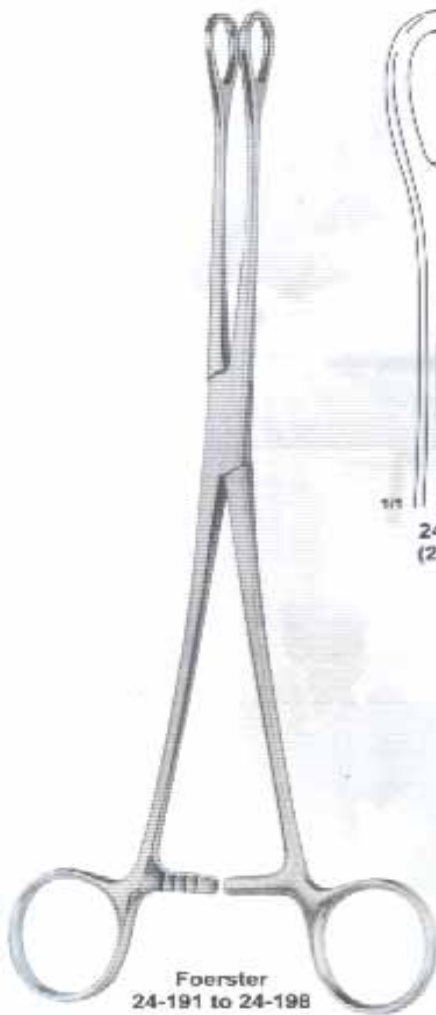

Foerster
24-191 to 24-198



24-191
(25cm)



24-192
(18cm)
24-193
(20cm)
24-194
(25cm)



24-195
(25cm)



24-196
(18cm)
24-197
(20cm)
24-198
(25cm)



CLIPS APPLYING FORCEPS



Olivecrona-Toennis
(Scoville)
25-199



McKenzie
25-200 (15cm)
25-201 (19cm)



McKenzie
25-202 (15cm)
25-203 (19cm)



Raney
25-204



Raney
25-205

TISSU & ORGAN HOLDING FORCEPS



Lovelace
26-206
(20cm)

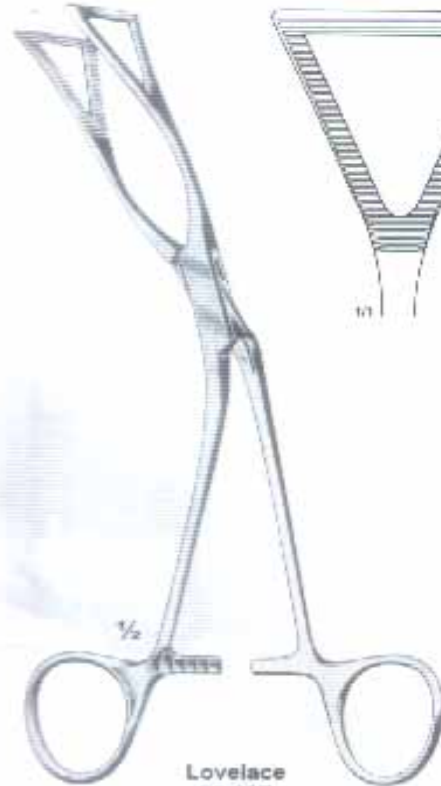

Lovelace
26-207
(20cm)

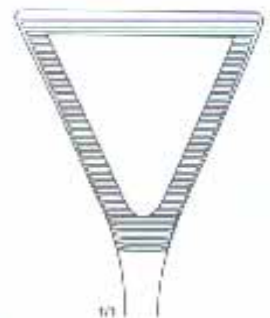

Collin
26-208
(14cm)

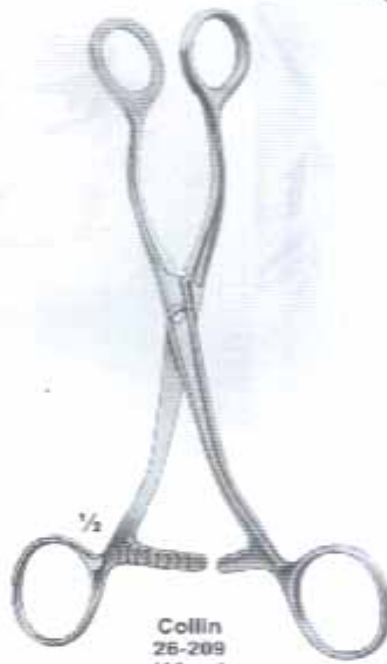

Collin
26-209
(16cm)

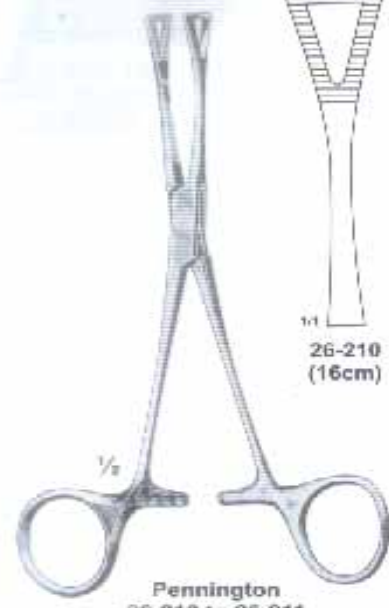

Pennington
26-210 to 26-211



26-210
(16cm)



26-211
(20cm)



DRESSING FORCEPS



STANDARD
27-212 to 27-1103



- 27-212 (11cm)
- 27-213 (13cm)
- 27-214 (14.5cm)
- 27-215 (16cm)
- 27-216 (18cm)
- 27-217 (20cm)
- 27-218 (25cm)
- 27-219 (30cm)



Taylor
27-220
(17cm)



Semken
27-221 to 27-222



27-221
(12cm)



27-222
(15cm)



Standard
27-223 to 27-231



- 27-223 (10cm)
- 27-224 (11cm)
- 27-225 (13cm)
- 27-226 (14.5cm)
- 27-227 (16cm)
- 27-228 (18cm)
- 27-229 (20cm)
- 27-230 (25cm)
- 27-231 (30cm)



Adson
27-232 to 27-233



27-232
(12cm)



27-233
(15cm)



McIndoe
27-234
(15cm)



TISSUE FORCEPS



28-235
to
28-243



- 28-235 (10cm)
- 28-236 (11.5cm)
- 28-237 (13cm)
- 28-238 (14.5cm)
- 28-239 (16cm)
- 28-240 (18cm)
- 28-241 (20cm)
- 28-242 (25cm)
- 28-243 (30cm)



Stille
28-244
(15cm)



Stille
28-245
(15cm)



Gillies
28-245/A
(15cm)



28-246
to
28-248



- 28-246
(13cm)
- 28-247
(14.5cm)
- 28-248
(16cm)



Stille
28-249
(15cm)



28-250
to
28-252



- 28-250
(13cm)
- 28-251
(14.5cm)
- 28-252
(16cm)



28-253
to
28-255



- 28-253
(13cm)
- 28-254
(14.5cm)
- 28-255
(16cm)



28-256
to
28-261



- 28-256
(13cm)
- 28-257
(14.5cm)
- 28-258
(16cm)
- 28-259
(20cm)
- 28-260
(25cm)
- 28-261
(30cm)

NEEDLE HOLDERS

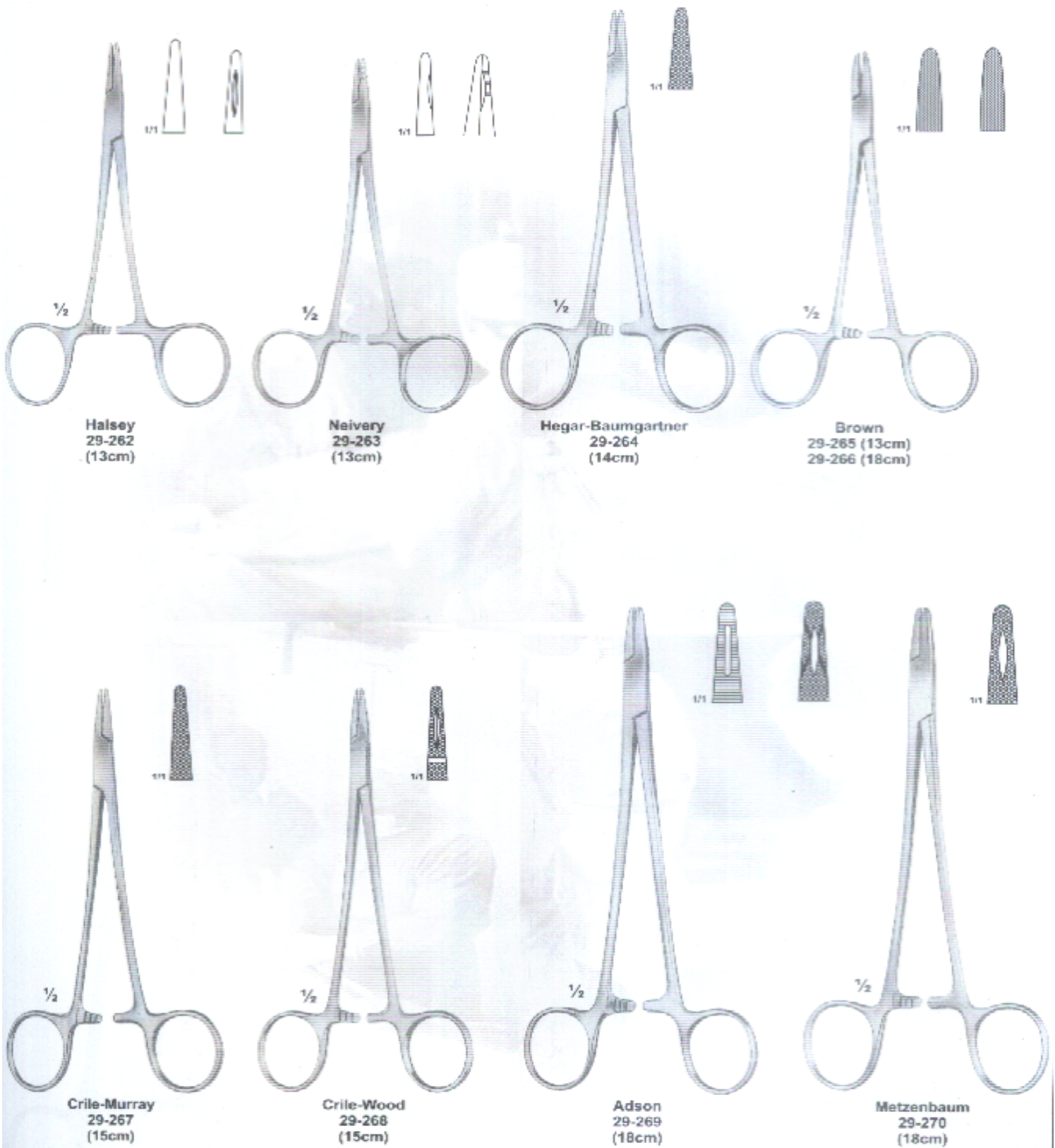

NEEDLE HOLDERS

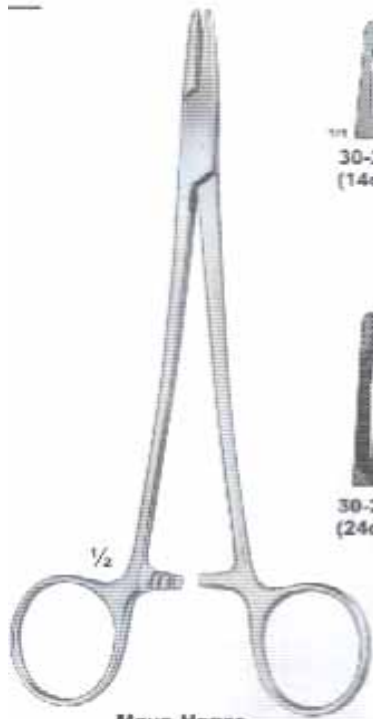

Mayo-Hegar
30-271 to 30-277



30-271
(14cm)



30-272
(16cm)



30-273
(18cm)



30-274
(20cm)



30-278
(14cm)



30-279
(18cm)



30-280
(20cm)



30-275
(24cm)



30-276
(26cm)



30-277
(30cm)

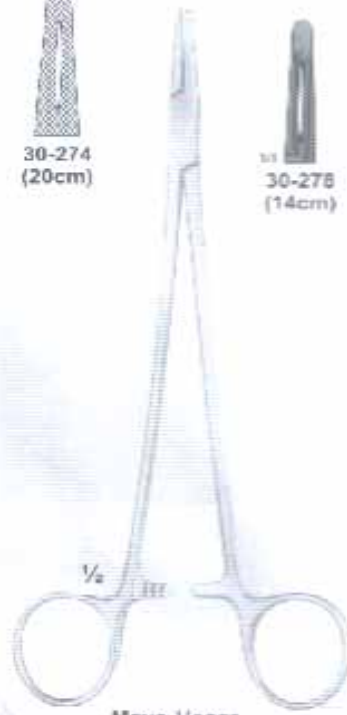

Mayo-Hegar
30-278 to 30-280



30-280/A



30-281



30-1166

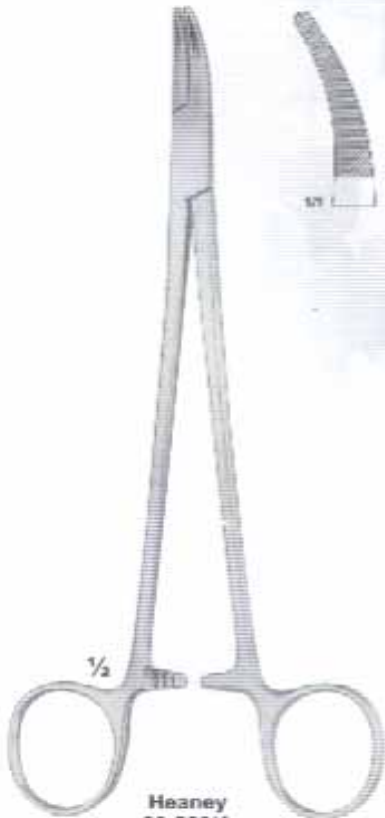

Heaney
30-280/A
(21cm)



Jamison
30-281
(23cm)

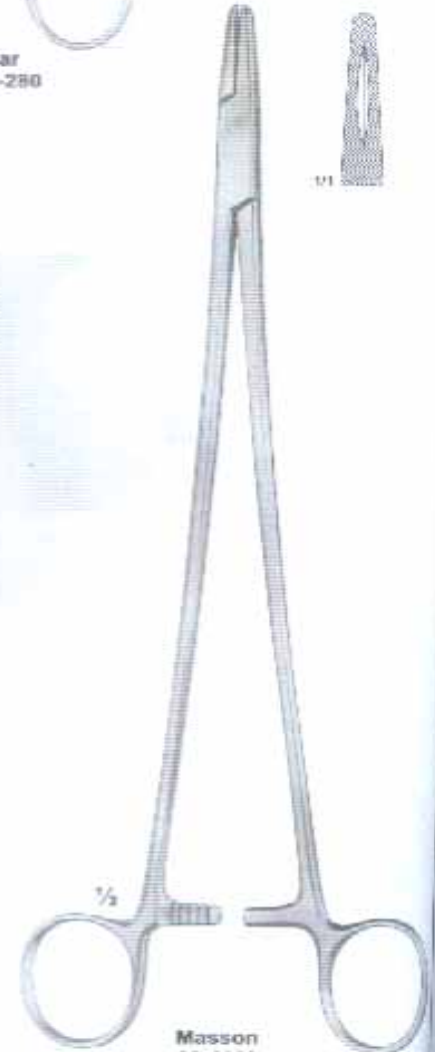

Masson
30-1166
(27cm)



NEEDLE HOLDERS



Crile
31-283
(15cm)



Toemmis
31-284
(18cm)



Stratte
31-285
(23cm)

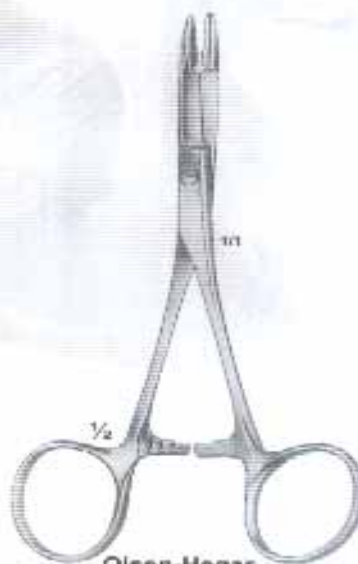

Olsen-Hegar
31-286
(14cm)



Gillies
31-287
(16cm)



NEEDLE HOLDERS



Castroviejo
32-288
(13cm)



Arruga
32-289 to 32-290
(16cm)



Castroviejo
32-291 to 32-292
(14cm)



Darf
32-293 to 32-294
(12cm)



Collier
32-295 to 32-296
(12.5cm)

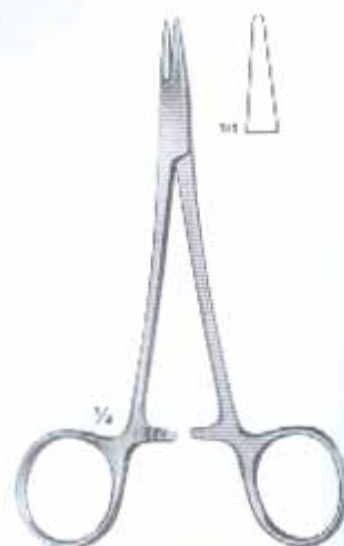

Webster
32-297
(13cm)



MICRO, NEEDLE HOLDERS



Mathieu
33-298
to
33-300



33-298
(14cm)



33-299
(17cm)



33-300
(20cm)



Lichtenberg
33-301
(20cm)



33-303
(23cm)



33-304
(23cm)



33-305
(19cm)



33-302
(16cm)



Mathieu
33-303
to
33-305



33-306
(14cm)



33-307
(17cm)



Mathieu
33-306
to
33-307



33-308
(17cm)



33-309
(20cm)



Mathieu
33-308
to
33-309

PLASTER CAST INSTRUMENTS PLASTER KNIVES, SAWS



Hennig
34-310
(28cm)

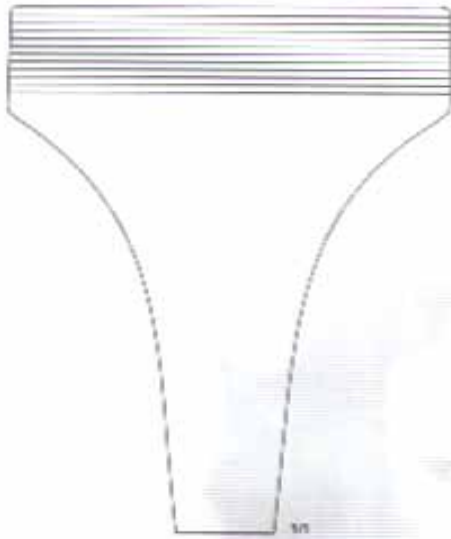

Wolff



34-311
(18cm)



34-312
(24cm)



Esmarch
34-313
(18cm)



Reiner
34-314
(18cm)



Hopkins
34-315
(20cm)



Engel
34-316
(14cm)

BONE HOLDING CLAMPS AMPUTATING & RESECTION SAWS

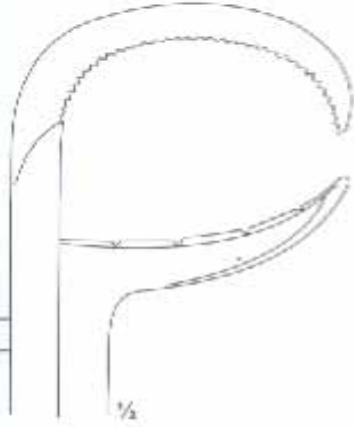

1/2

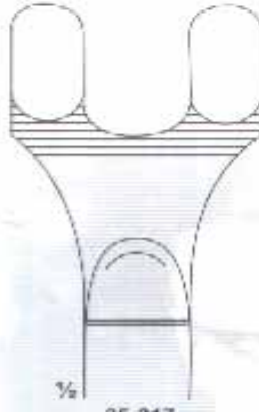

1/2

35-317
(18cm)



Spare Saw Blade
35-324 (12cm)
35-325 (15cm)



Charriere
35-323
(35cm)

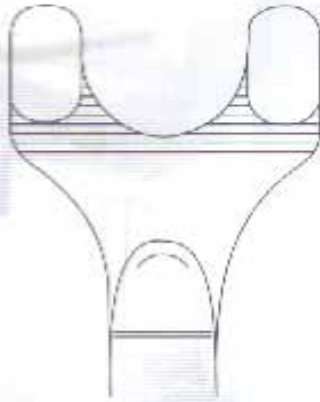

35-318
(20cm)

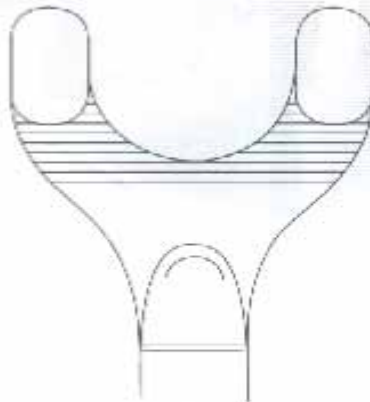

35-319
(22cm)



Gerster-Lowmann
35-317 to 35-319



1/4

Charriere
35-320 (27cm)
35-321 (30cm)



1/4

Satterlee
35-322 (31cm)

MALLETS, GOUGES & PERIOSTEAL ELEVATORS

With Interchangeable
Ferrozell Faces
26 mm



1/2
Mead
36-328
(17 cm)



1/2
Partsch
36-327
(18 cm)

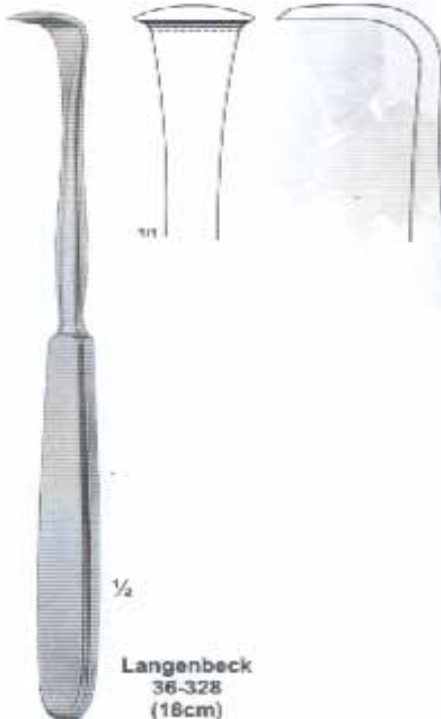

1/2
Langenbeck
36-328
(18cm)

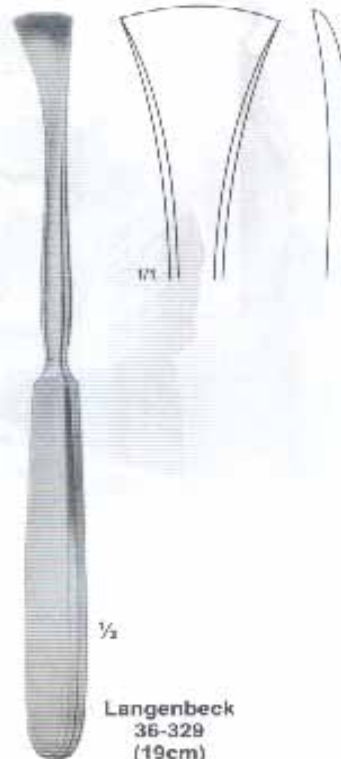

1/2
Langenbeck
36-329
(19cm)



Hibbs
36-330
to
36-334

36-330
(6mm)

36-331
(13mm)

36-332
(19mm)

36-333
(25mm)

36-334
(32mm)



EXTENSION BOWS BONE WIRE TIGHTENERS

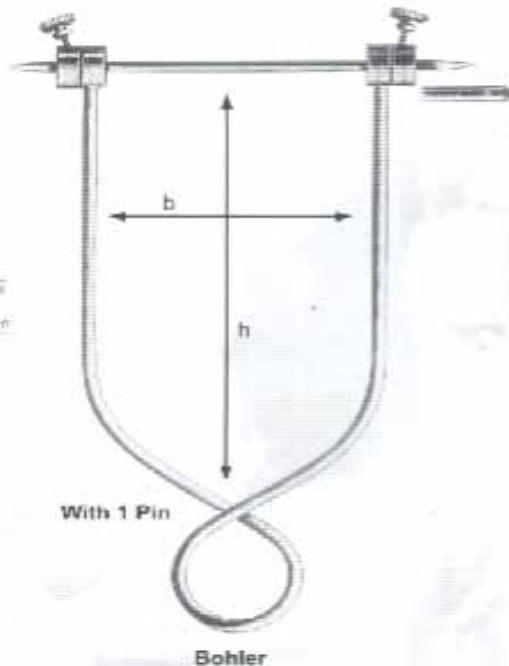
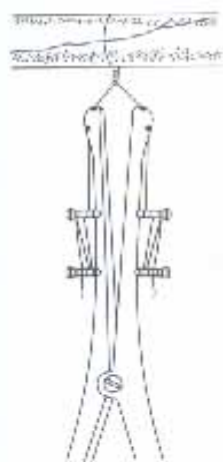

Kirschner
37-340
(18.5cm) 0-40mm
37-341
(27cm) 35-200mm

37-337	6 1/4 x 3 1/2	16x9	For Arm
37-338	8 1/4 x 4 1/2	21x11	For Thigh & Knee
37-339	8"x6"	21x15	For Femur & Knee

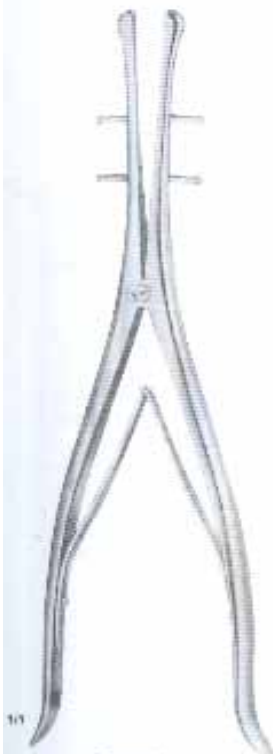

Demel
37-335
(28cm)



Loute
37-336
(21cm)



RASPATOIRES



Farabeufr
38-342
(15cm)

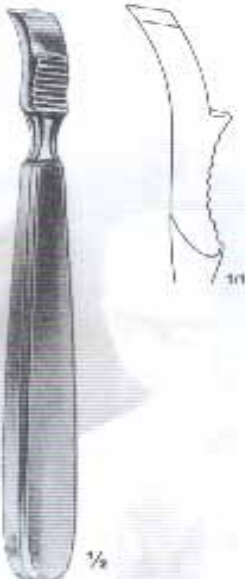

Farabeufr
38-343
(15cm)

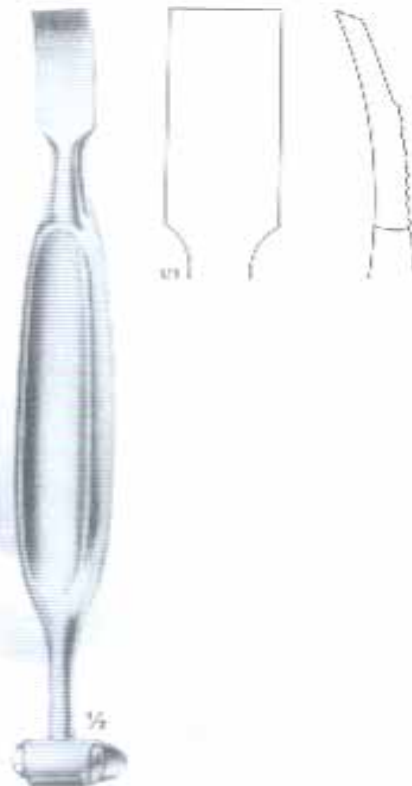

Alexander
38-344
(20cm)



Doyen
38-345 to 38-348



38-345



38-346

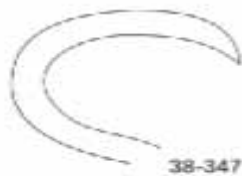

38-347



38-348



38-349 to 38-351



38-349
(5mm)



38-350
(6mm)



38-351
(7mm)



RETRACTORS



Mini-Langenbeck
38-352 to 39-355
(16cm)



39-352



39-353



1/1
39-354



39-355



Desmarres
38-356 to 39-361
(16cm)



39-356



39-357



39-358



39-359

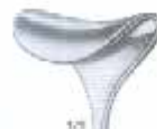

1/1
39-360



39-361



38-362 to 39-365
(16cm)



39-362



39-363



1/1
39-364



39-365



38-366 to 39-371
(16cm)



39-366



39-367



39-368



39-369



1/1
39-370



39-371



38-372 to 39-373
(16cm)



1/1
39-372



39-373



39-373

RETRACTORS

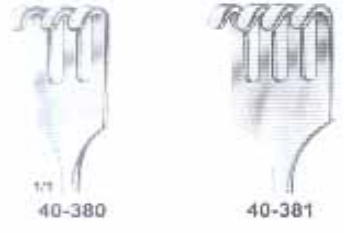
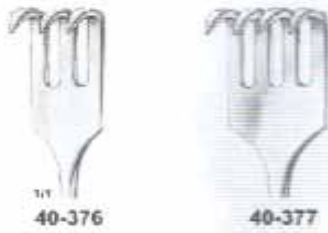
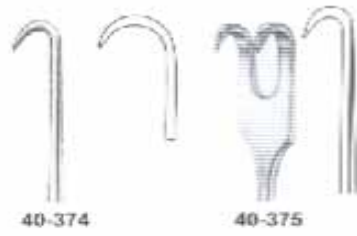

RETRACTORS



Gelpi-Loktite
41-390
(13cm)

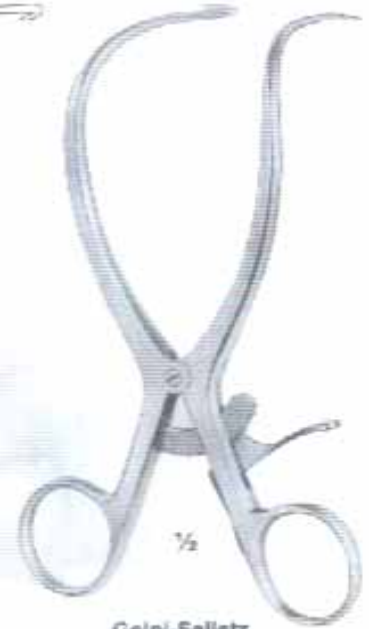

Gelpi-Selietz
41-391
(15cm)



Gelpi-Loktite
41-392
(18cm)

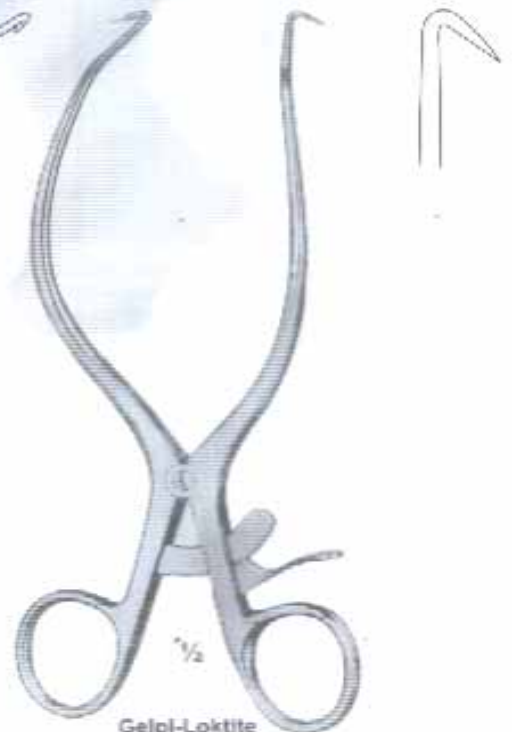

Gelpi-Loktite
41-393
(18cm)



RETRACTORS

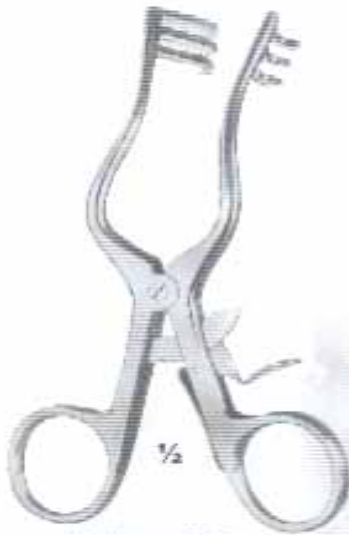

Weitlaner-Wullstein
42-394 to 42-395
(13cm)

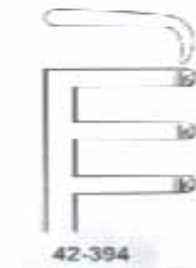

42-394

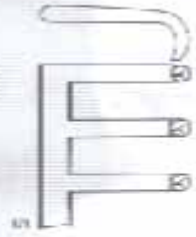

42-395

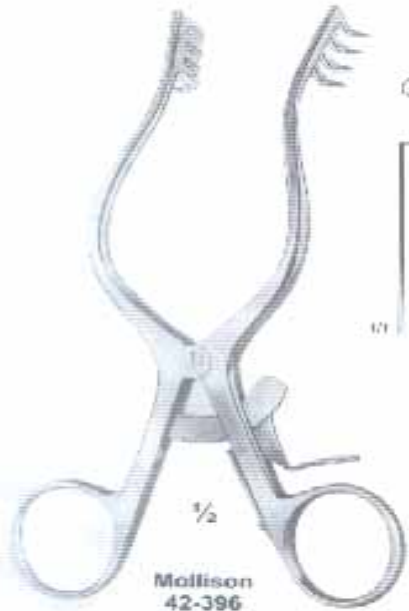

Mollison
42-396
(15cm)



1/2



Adson
42-397 to 42-400
(28.5cm)

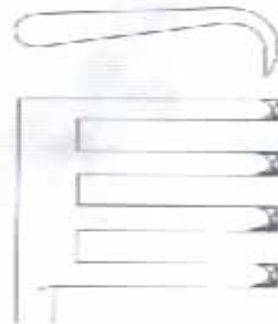

42-397

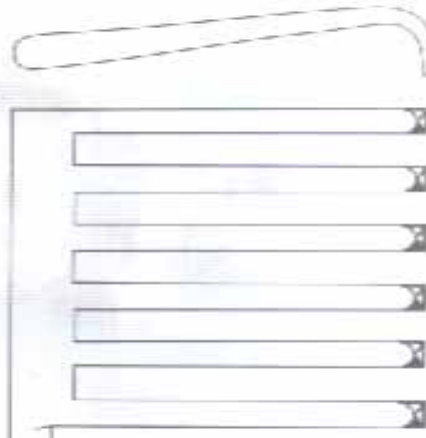

42-399



42-398

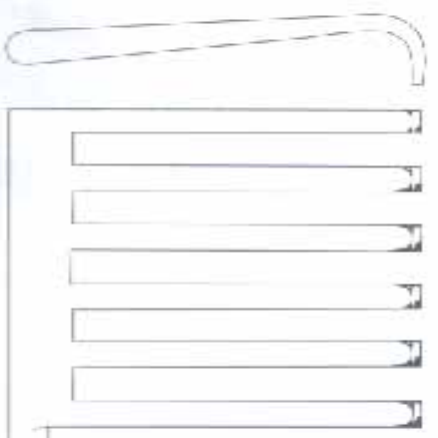

42-400



RETRACTORS





RETRACTORS



70x25 mm

1/2

Kocher
44-406
(22.5cm)

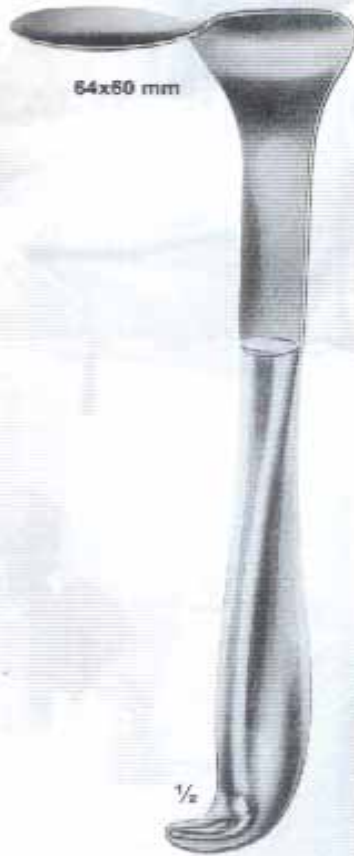

64x60 mm

1/2

Tuffer
44-407
(23cm)

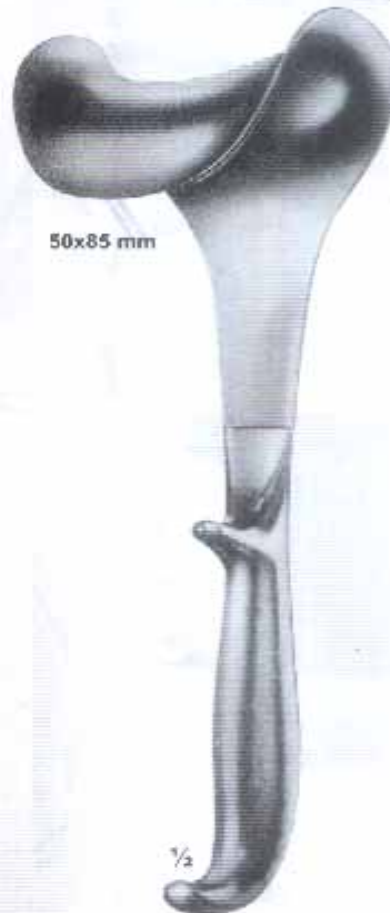

50x85 mm

1/2

Doyen
44-407/A
(25cm)



80x45 mm

1/2

Doyen
44-408 to 44-410
(25cm)
44-408 (80x45 mm)
44-409 (80x55 mm)
44-410 (80x65 mm)



RETRACTORS



1/2
Israel
45-411 to 44-414
(25cm)

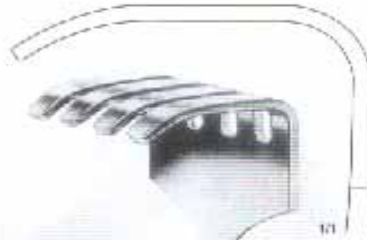

1/2
45-411
(40x40mm)



1/2
45-412
(40x50mm)



1/2
45-413
(50x60mm)



1/2
45-414
(70x70mm)



1/2
Langenbeck
45-415 to 45-419
(22cm)

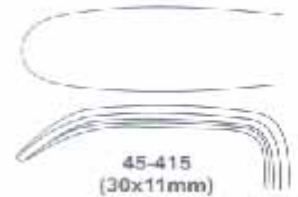

45-415
(30x11mm)

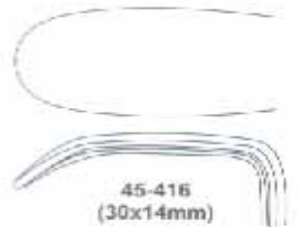

45-416
(30x14mm)



45-417
(30x16mm)

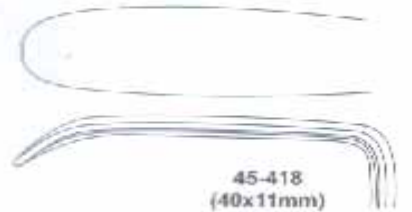

45-418
(40x11mm)

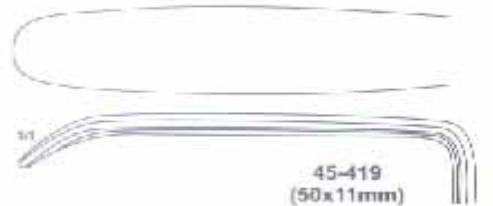

45-419
(50x11mm)



RETRACTORS



1/2
Richardson
46-420 to 46-422
(24cm)



46-420
(28x20mm)



46-421
(36x28mm)



46-422
(44x38mm)



1/2
Richardson
46-423
(24cm)

52x22 mm



1/2
Kelly
46-424
(26cm)

70x50 mm



1/2
Richardson-Eastmann
46-425 Fig.1 (26cm)
46-426 Fig.2 (28cm)

49x38 mm
28x20 mm

Fig.1 ▶

◀ Fig



ABDOMINAL RETRACTORS

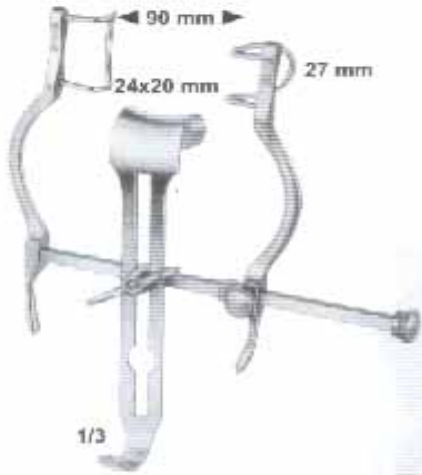

1/3
Balfour-Baby
47-427



Gosset
47-428



1/3
Balfour
47-429

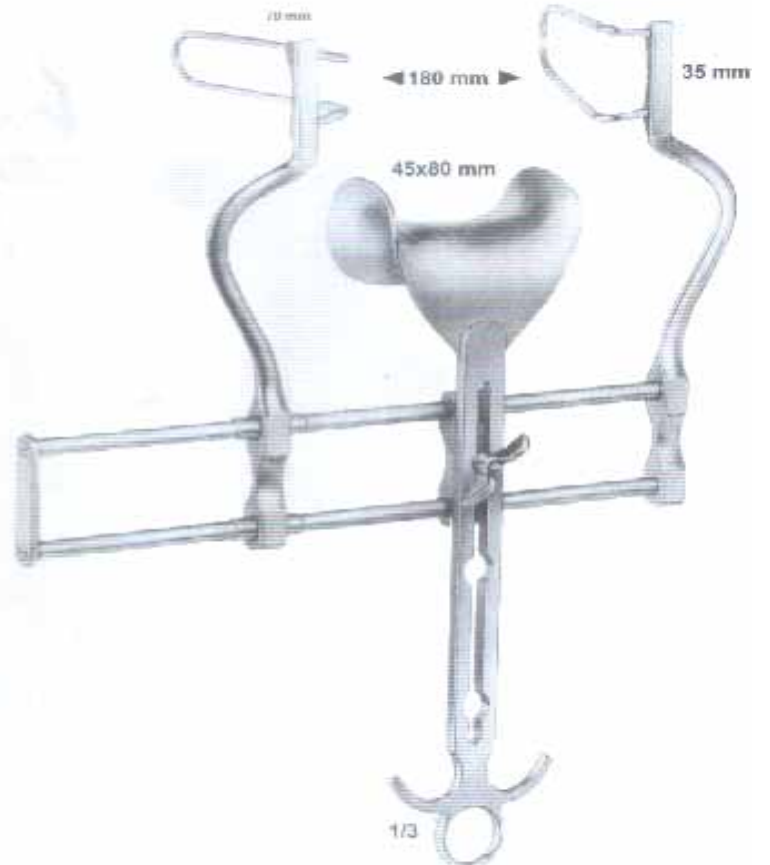

1/3
Balfour
47-430

■ ■ ABDOMINAL RETRACTORS ■ ■

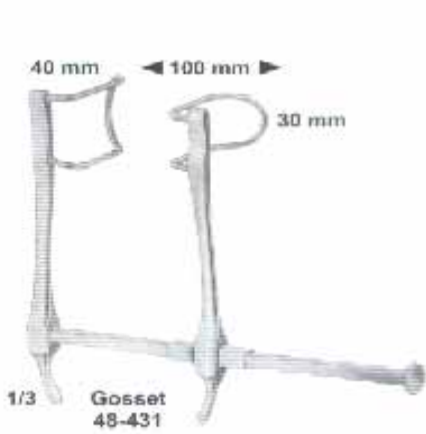

Gosset
48-431

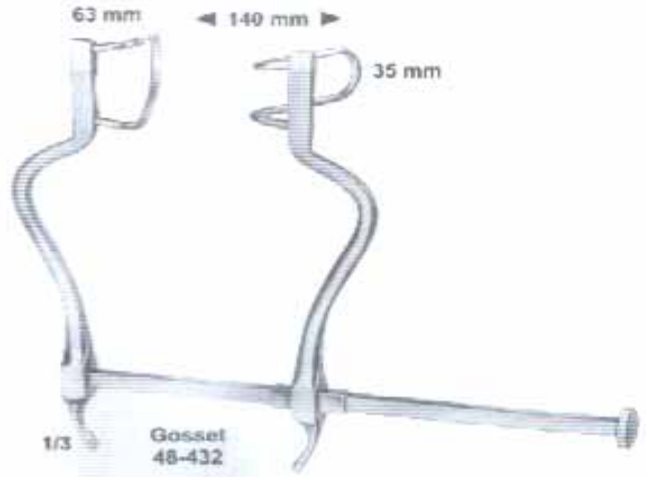

Gosset
48-432



Center Blade
48-434
55x70 mm
80x90 mm

Lateral Blades
48-435
50x58 mm
60x80 mm
72x85 mm

Ricard
48-433
(28cm)

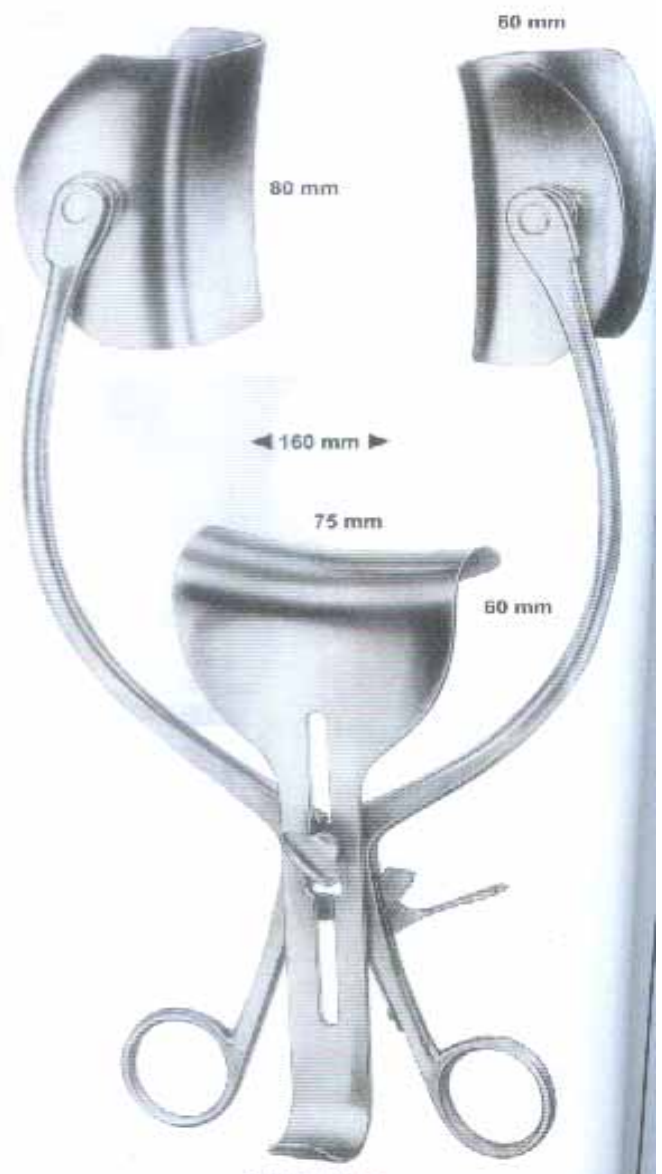

Collin-Loktite
48-436
(26cm)

SUCTION TUBES, TROCARS



Adson
49-437
(21cm)
4 mm



Frazier
(19cm)
49-438 6
49-439 8
49-440 10
49-440/A 12



Ochsner
(14cm)
49-441 (4mm)
49-442 (5.5mm)
49-443 (6.5)



Poole
49-444
(22cm)
10 mm



Poole
49-445
(22cm)
8 mm



Fig. 0
49-446



Fig. 1
49-447



Fig. 2
49-448



Fig. 3
49-449



Yankauer
49-446 to 49-449
(27cm)



1/2



1/2

Yankauer
49-450
(27cm)



BONE LEVERS



Blount
50-451
(26cm)

1/3



Blount
50-452
(26cm)

1/3



Bennett
50-453
(24cm)



Hohmann
50-455
(8 cm)

1/2



Hohmann
50-456
(18 cm)

1/2



Hohmann
50-457
(43 cm)

1/2



Hohmann
50-458
(70 cm)

1/2





BONE HOLDING FORCEPS

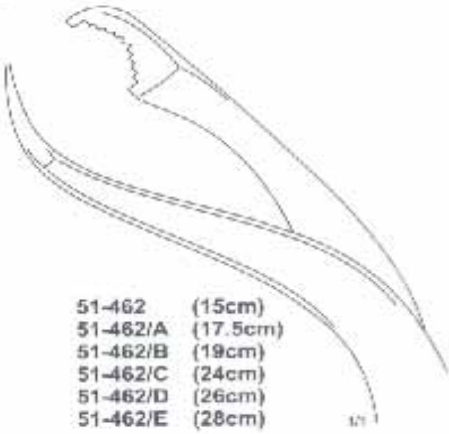

- 51-462 (15cm)
- 51-462/A (17.5cm)
- 51-462/B (19cm)
- 51-462/C (24cm)
- 51-462/D (26cm)
- 51-462/E (28cm)

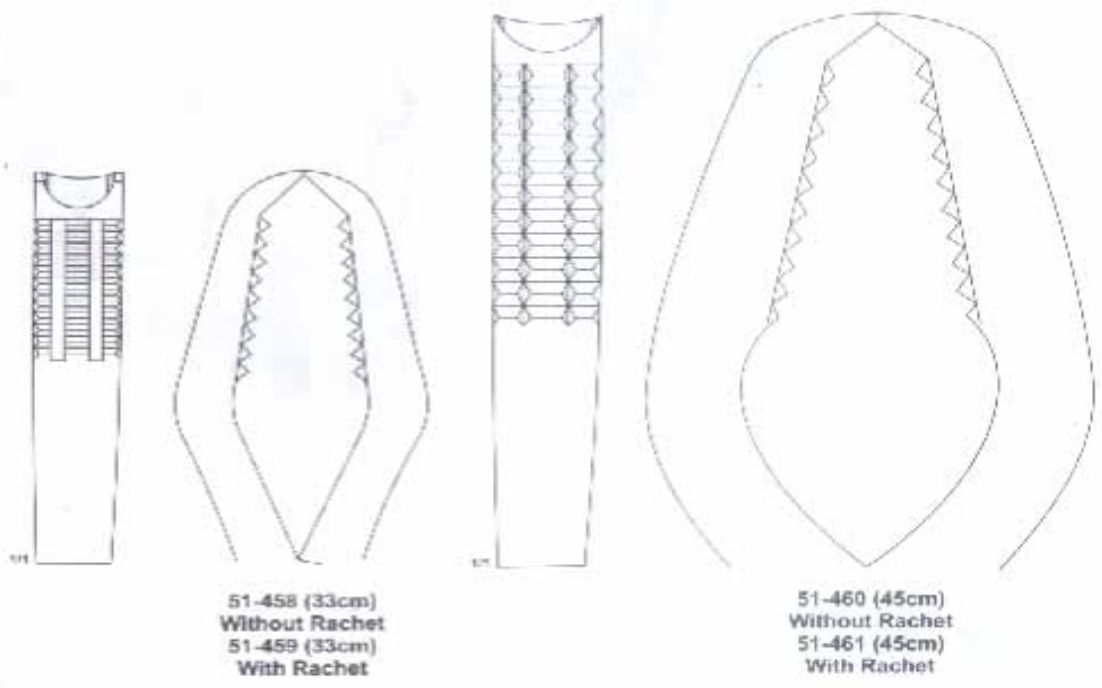
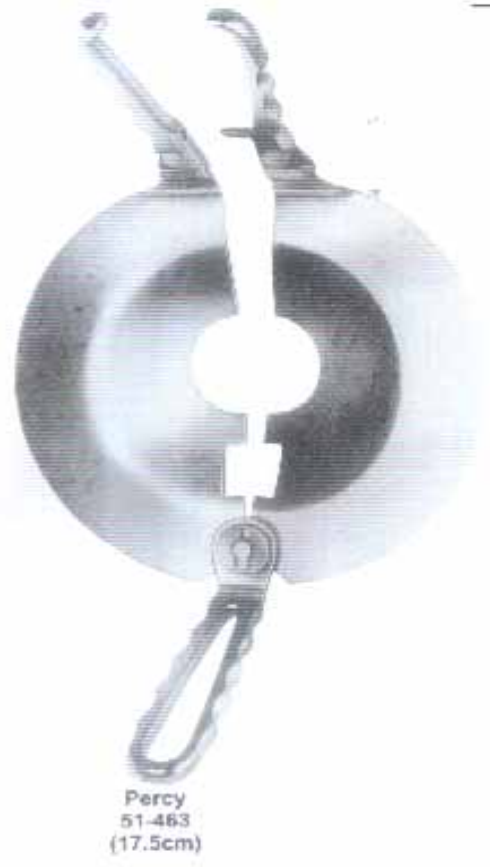



BONE HOLDING FORCEPS

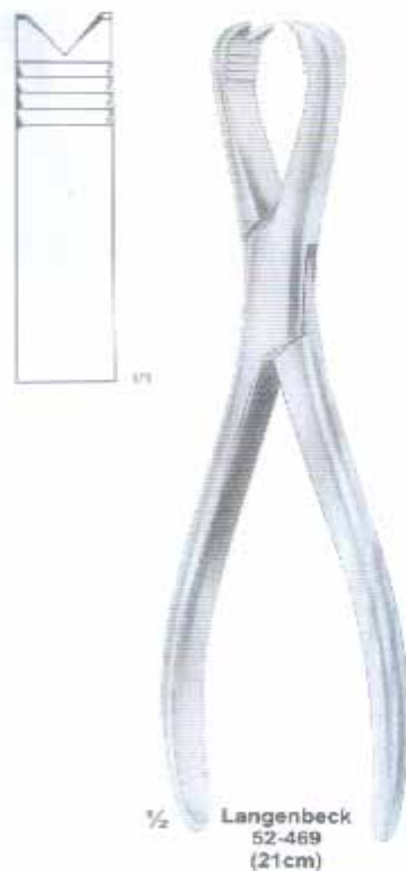
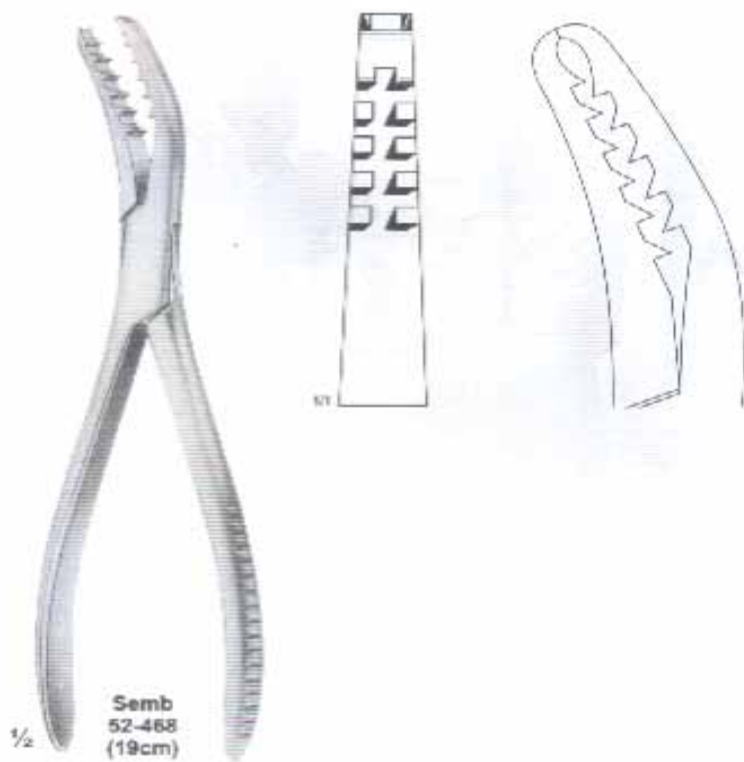
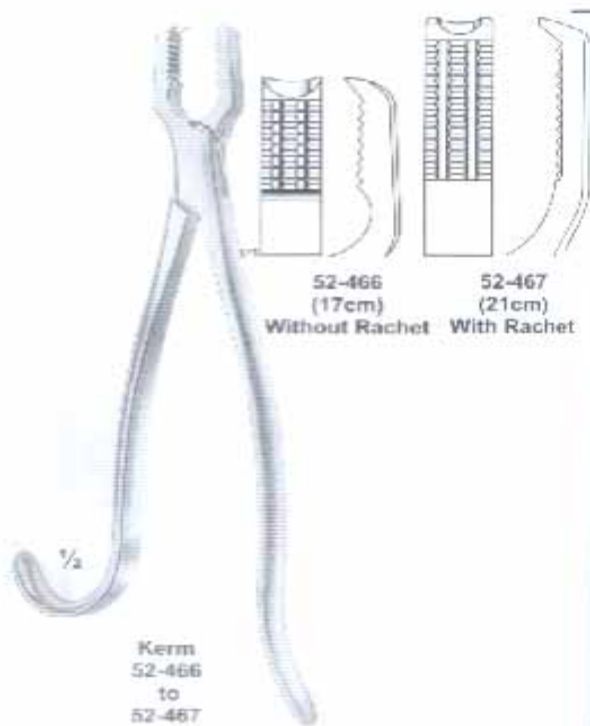
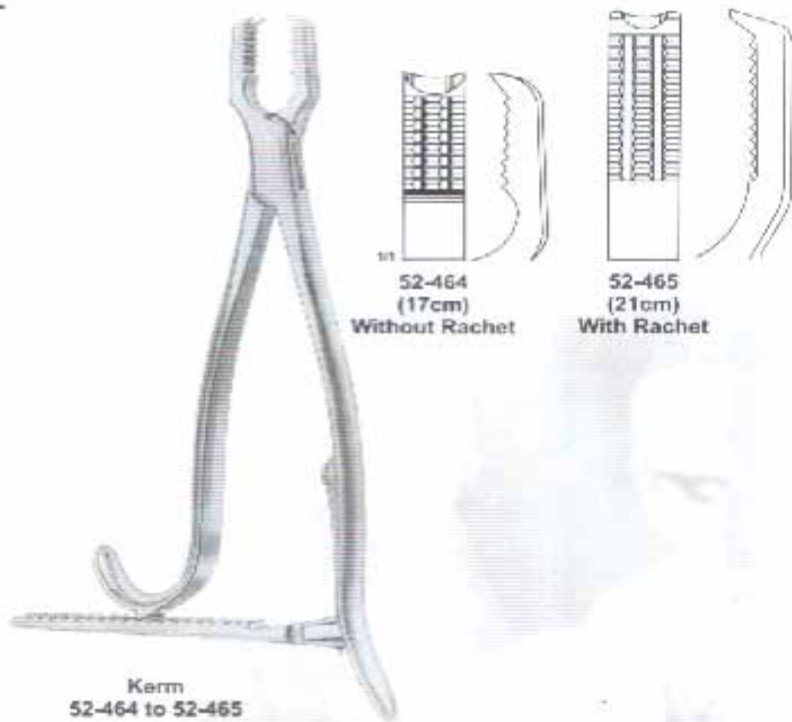



BONE CUTTING FORCEPS



53-470
(23cm)



53-471
(27cm)



1/2

Liston-Key
53-470 to 53-471

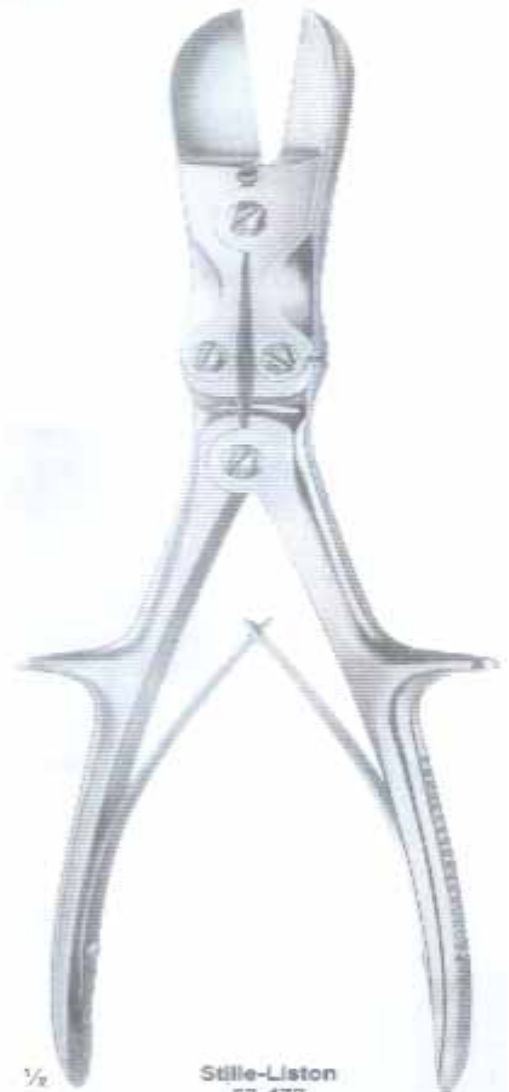

1/2

Stille-Liston
53-472
(27cm)



BONE RONGEUR FORCEPS

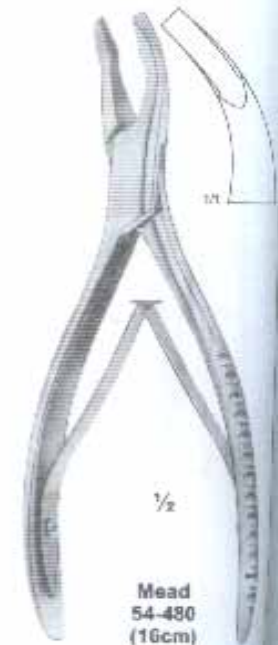
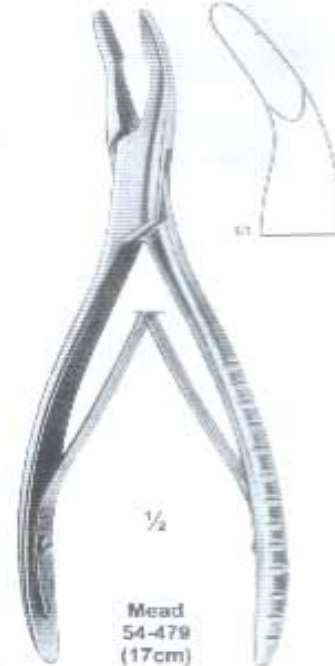
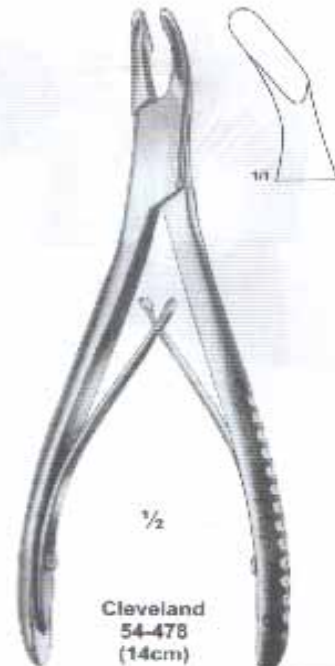
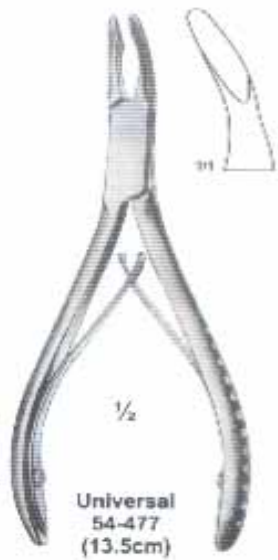
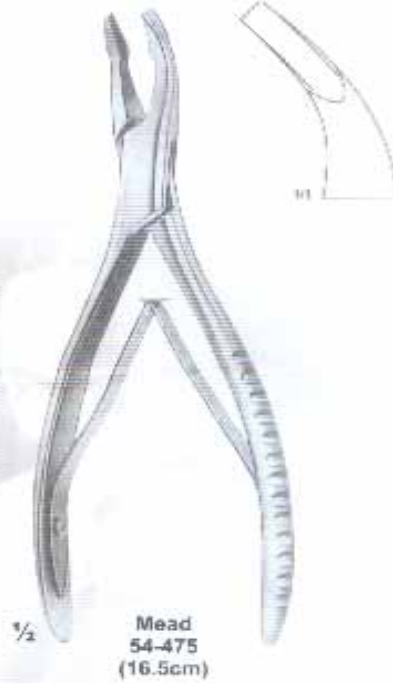



BONE RONGEUR FORCEPS



Mayfield
55-481
(17cm)



Marquardt
55-482
(20cm)

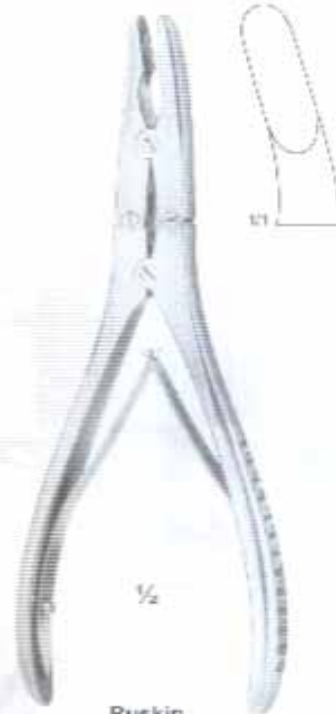

Ruskin
55-483
(18cm)

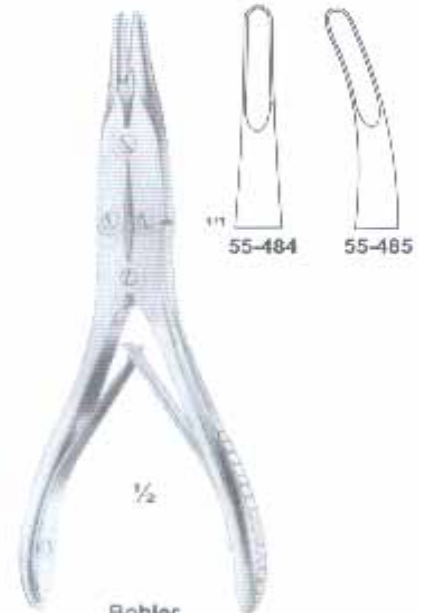

Bohler
55-484
to
55-485



Blumenthal
55-486 to 55-488

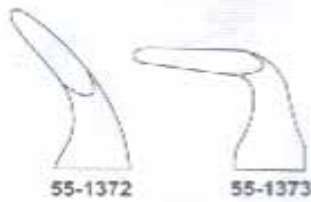

55-1371

55-1372

55-1373

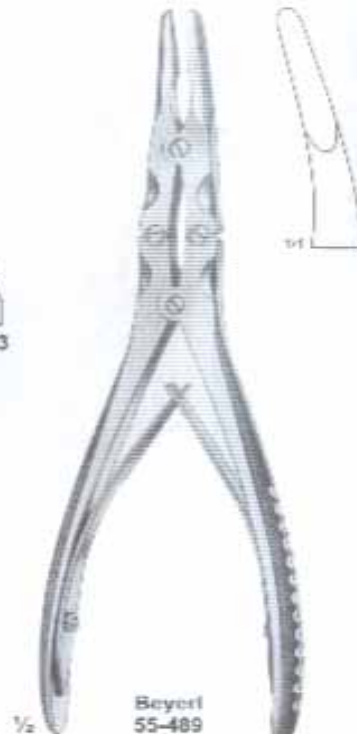

Beyerl
55-489
(18cm)



Zaufal-Janseni
55-490
(18cm)



BONE RONGEUR FORCEPS

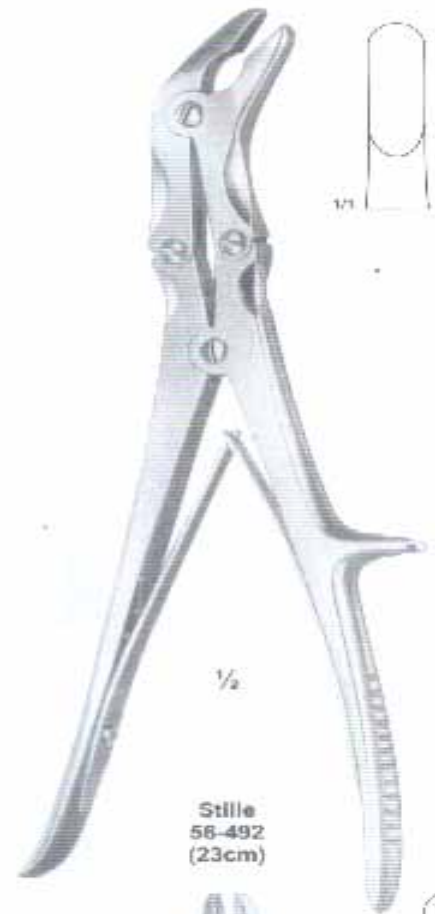
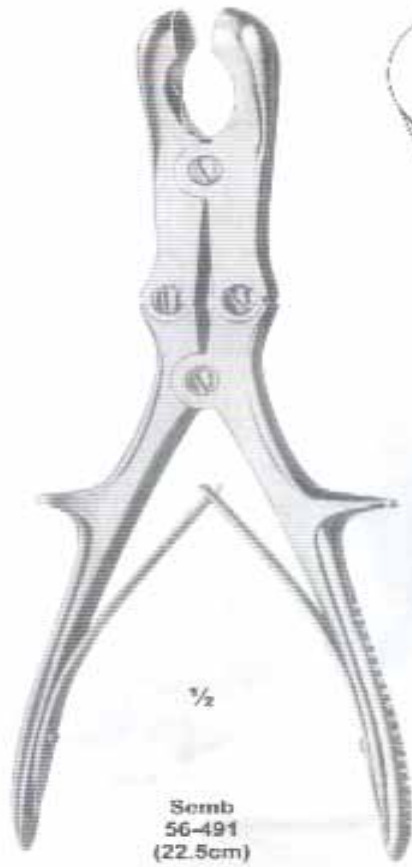



VAGINAL SPECULA



Cusco
 57-497 (75x32 mm)
 57-498 (85x35 mm)
 57-499 (100x37 mm)

1/2



Cusco
 57-506
 (S.M.L.)



Pederson
 57-500 (75x13 mm)
 57-501 (100x22 mm)
 57-502 (120x25 mm)

1/2



Sakuras
 57-507
 (S.M.L.)

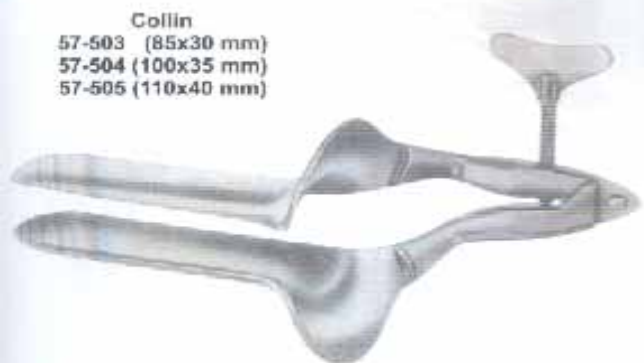

Collin
 57-503 (85x30 mm)
 57-504 (100x35 mm)
 57-505 (110x40 mm)



Grave
 57-508 (75x20 mm)
 57-509 (95x35 mm)
 57-510 (115x35 mm)



VAGINAL SPECULA



Sims

- 58-511 (65x25 mm)
(70x30 mm)
- 58-512 (70x30 mm)
(70x35 mm)
- 58-513 (85x35 mm)
(90x40 mm)

1/2



Kristeller

- Fig. 1 58-514 (70x27 mm)
- Fig. 2 58-515 (80x30 mm)
- Fig. 3 58-516 (90x36 mm)

1/2



Kristeller

- Fig. 1 58-517 (75x23 mm)
- Fig. 2 58-518 (85x26 mm)
- Fig. 3 58-519 (100x32 mm)

1/2



Semm

- 58-520 (100x17/20 mm)
- 58-521 (100x25/30 mm)

1/2



Jackson

- 58-522 (75x35 mm)
- 58-523 (90x35 mm)
- 58-524 (100x35 mm)
- 58-525 (75x40 mm)
- 58-526 (90x40 mm)
- 58-527 (100x40 mm)

1/2



Kristeller

- Fig. 1 58-528
- Fig. 2 58-529
- Fig. 3 58-530

1/2

ANAL RETRACTORS, RECTAL SPECULA SPHINCTEROSCOPIES, ANOSCOPE, PROCTOSCOPIES



Kelly
59-531 (21 mm Ø x 50 mm)
59-532 (27 mm Ø x 50 mm)

½



Kelly
59-533 (22 mm Ø x 50 mm)
59-534 (22 mm Ø x 100 mm)
59-535 (22 mm Ø x 140 mm)

½



Newman
59-536 (16 mm Ø x 63 mm)
59-537 (19 mm Ø x 63 mm)
59-538 (23 mm Ø x 63 mm)

½



90 x 15 mm

Mathieu
59-539
(19.5 cm)

½



Hirschmann
59-540 (16 mm Ø x 65 mm)
59-541 (19 mm Ø x 65 mm)
59-542 (23 mm Ø x 65 mm)

½



Barr
59-543
(17 cm)

½

UTERINE SOUNDS AND DEPRESSORS



Sims
60-544 (32cm)
60-545 (32cm)



Sims
60-546 (32cm)
60-547 (32cm)



Valleix
60-548
(25cm)



Braun
60-549
(28cm)



Uterine Probe
60-550



UTERINE DILATORS



Set of 5 Dilators

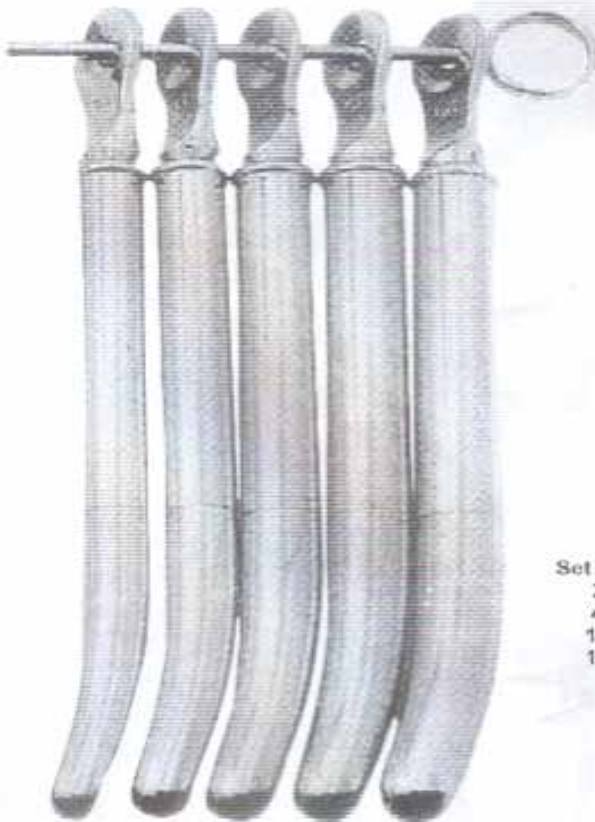

61-554

Hegar
61-552
Set of 8 Dilators
3.0 mm Ø
4.0 mm Ø
17.0 mm Ø
18.0 mm Ø



61-551
Set of 8 Dilators
3.0 mm Ø
4.0 mm Ø
17.0 mm Ø
18.0 mm Ø

Hegar
61-553
Set of 13 Dilators
1.0 mm Ø
2.0 mm Ø
25.0 mm Ø
28.0 mm Ø

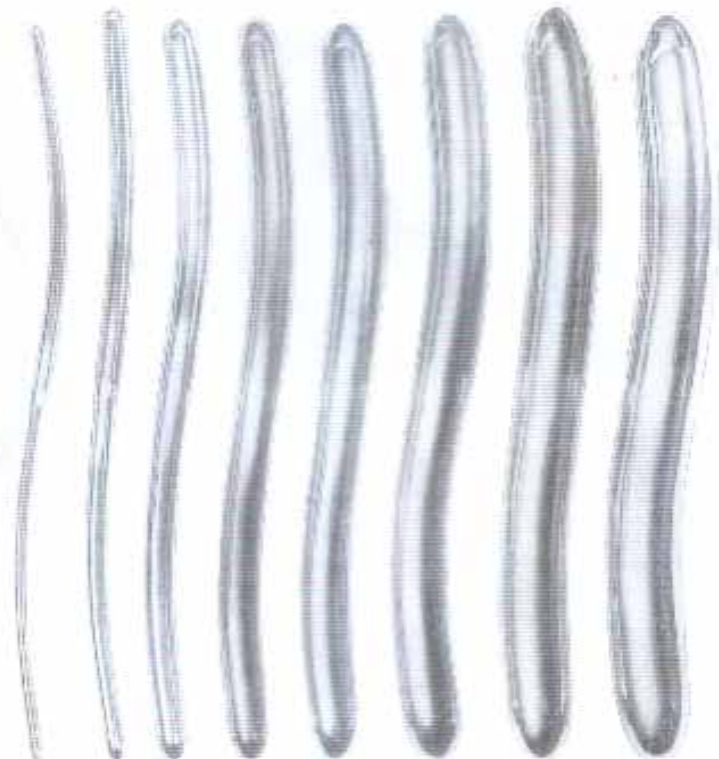

ANTRUM PUNCH FORCEPS SPHENOID PUNCHES

4x4 mm

62-556
(4 mm)

5x5 mm

62-557
(5 mm)

6x6 mm

62-558
(6 mm)

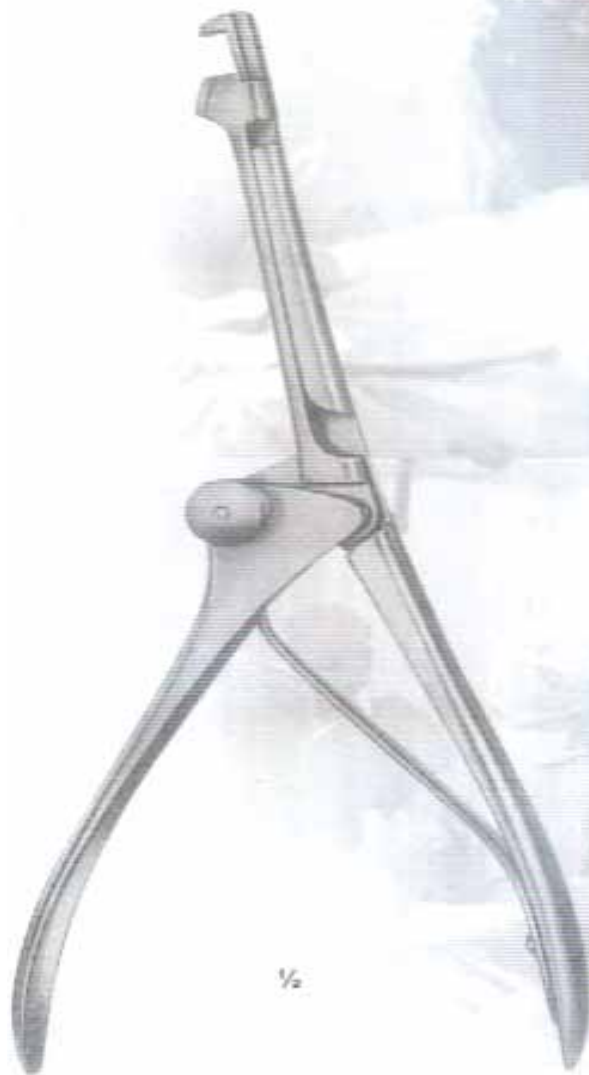

Hajek-Claus
62-555
(20cm)



Kerrison
62-556 to 62-558
(20cm)



PUNCHES AND CURETTES



Langenbeck
63-559
(13cm)

Shapleigh
63-560 to 63-563
(13cm)



63-560



63-561



63-562



63-563



Coxter
63-564
(15cm)



Beyer
63-565



Beyer
63-566

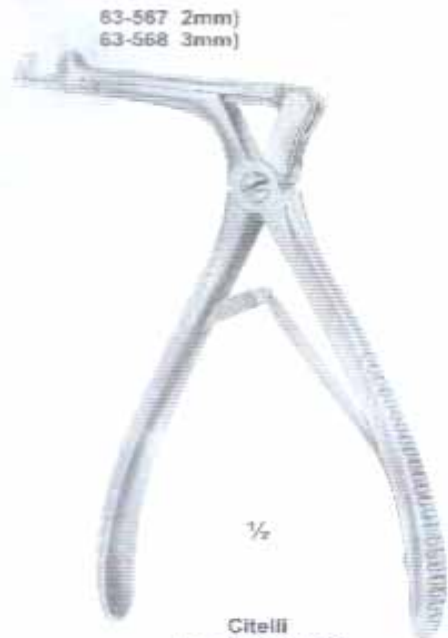

Citelli
63-567 to 63-568

■ ■ SEPTUM COMPRESSION FORCEPS ■ ■



Middleton-Jansen
64-569
(19cm)

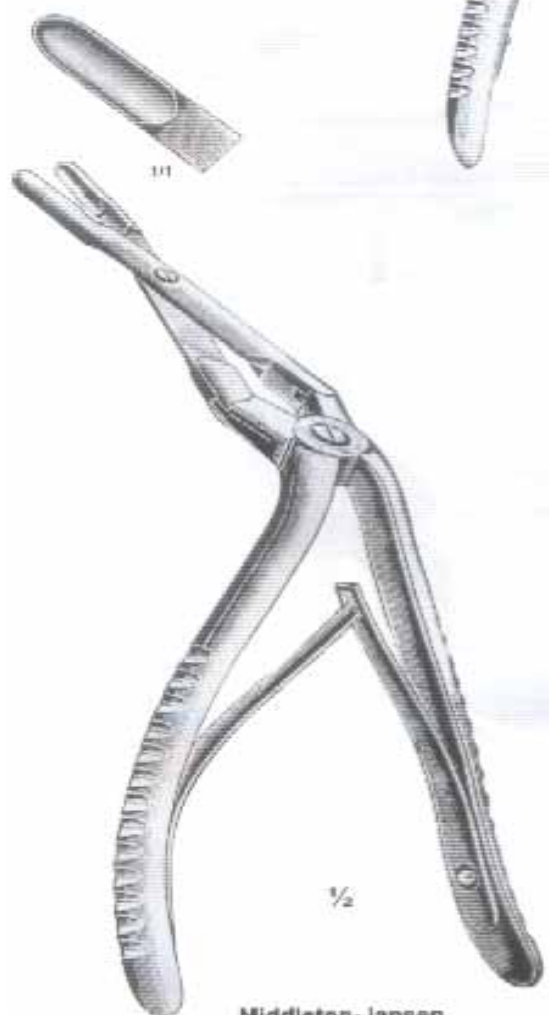

Middleton-Jansen
64-570
(19cm)



Jansen-Struycken
64-571
(19cm)

CERVICAL BIOPSY & SPECIMEN FORCEPS

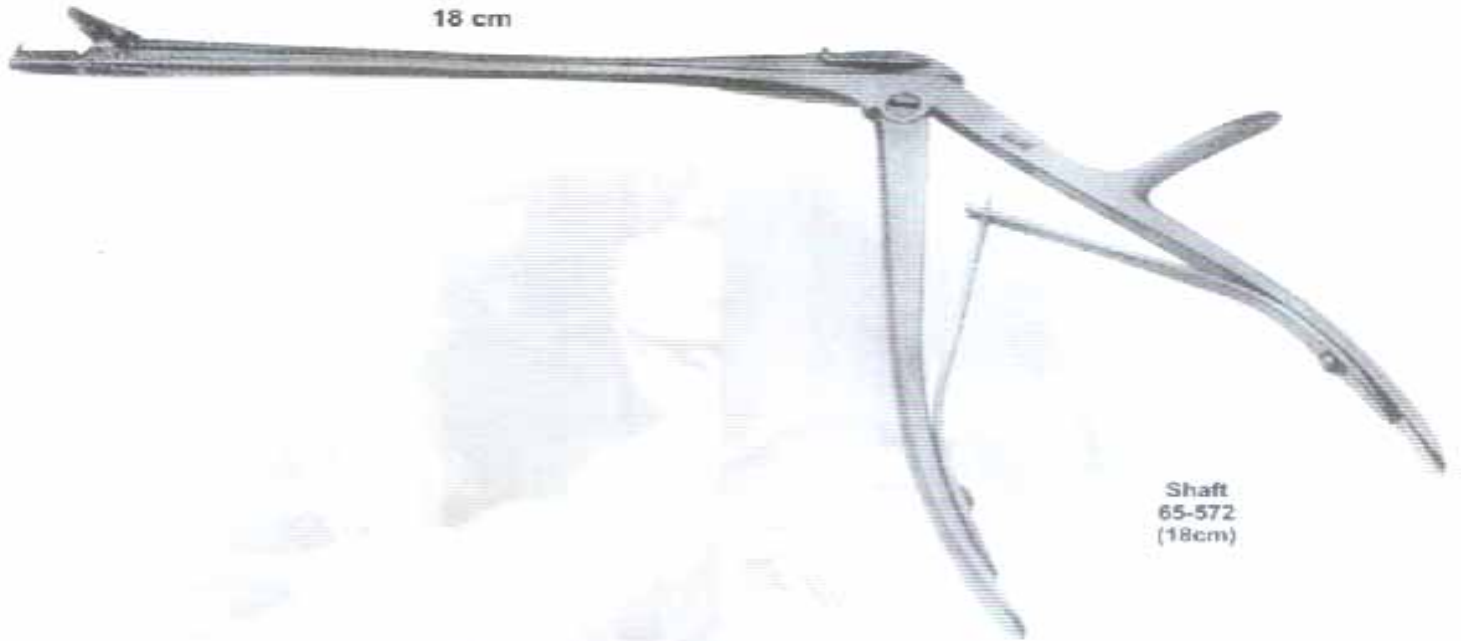



NASAL SPECULA

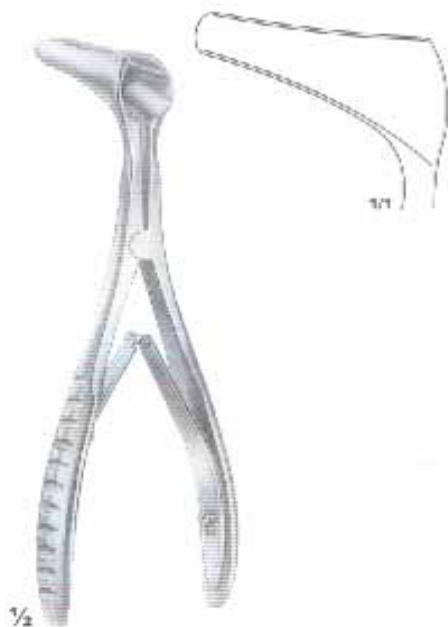

Mod-Wien
66-574
(14.5cm)



Killian
66-575
to
66-578
(13cm)

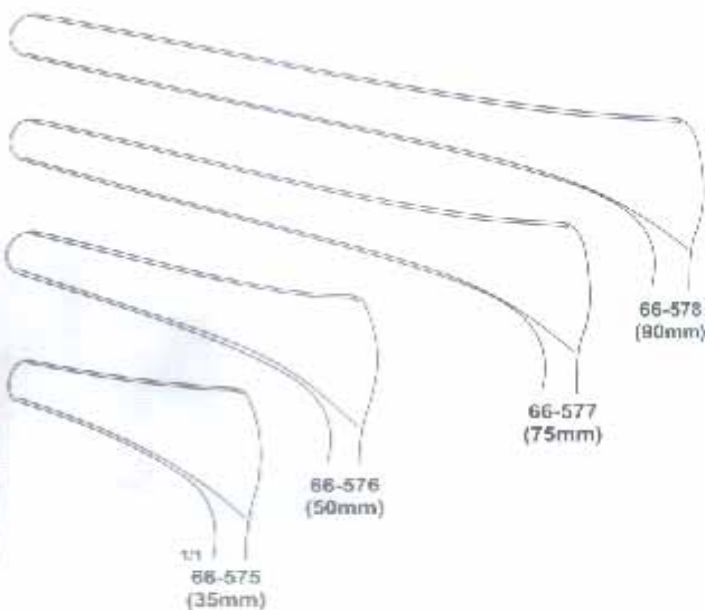

66-576
(50mm)

66-577
(75mm)

66-578
(90mm)

1/1
66-575
(35mm)



66-579
(13cm)



Tieck-halle
66-580
(13.5cm)



66-581
(13cm)



Tieck-Halle
66-582
(13.5cm)

EAR DRESSING FORCEPS EAR POLYPUS SNARES



67-585
(0.3 mm o)
67-586
(0.4 mm o)

Steel Wire For Ear Snares

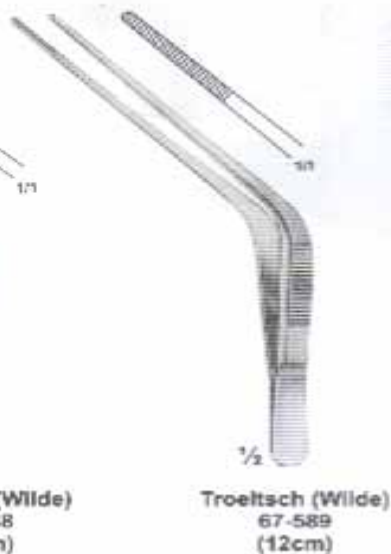

EAR POLYPUS FORCEPS



Hartmann-Wullstein
88-594
(8.5cm)



Hartmann-Wullstein
68-595
(8.5cm)



Hartmann
68-596 (8.5cm)
68-597 (14cm)
68-598 (16.5cm)



Hartmann
68-599 (8.5cm)



Hartmann-Noyes
68-600
(9cm)



Hartmann-Noyes
68-601
(9cm)



Hartmann-Weingartner
68-602
(8.5cm)



Hartmann
68-603
(8.5cm)

○ 2 mm

○ 2.5 mm

○ 3 mm

○ 3 mm

○ 2 mm



Hartmann
68-604 (2 mmO)
68-605 (2.5 mmO)
68-606 (3 mmO)



Hartmann
68-607
(8.5cm)



Struempel
68-608
(8.5cm)



Hartmann-Hoffmann
68-609
(8.5cm)



88-594 to 68-609

TONGUE DEPRESSORS, CHEEK AND LIP RETRACTORS



½
Andrew
69-610
(11cm)



½
Hartmann
69-611
(15cm)



½
Tobold
69-612
(14.5cm)



½
Tobold
69-613
(14.5cm)



½
Wieder
69-614 to 69-615



½
69-614
(14cm)



69-615
(15cm)



Sternberg
69-616 (12cm)
69-617 (14cm)
69-618 (16cm)



Sternberg
69-619 (14cm)
69-620 (16cm)
69-621 (18cm)



Jennings
69-622 (9cm)
69-623 (11cm)
69-624 (13cm)
69-625 (15cm)



MOUTH GAGS



1/2
Denhart
70-626
(12cm)



Rosser-Konig
70-627 (16cm)
70-628 (20cm)



1/2
Heister
70-629
(13cm)



1/2
Molt
70-630
(11cm)



1/2
Molt
70-631
(14cm)



TONSIL SNARES

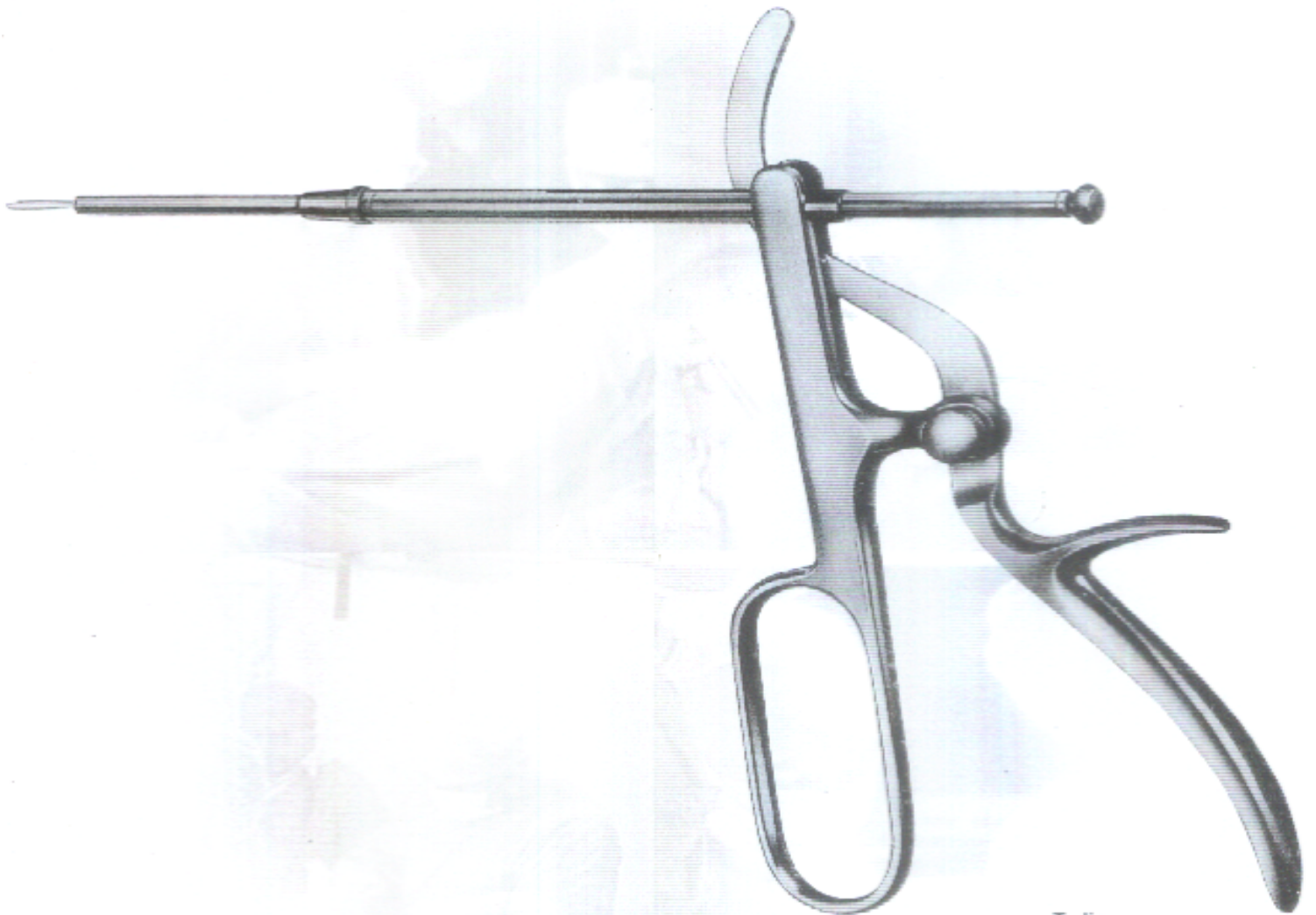

Tyding
71-632
With 1 Straight Tip



TONGUE HOLDING FORCEPS



1/2
Young
72-634
(17cm)



1/2
Collin
72-633
(17cm)

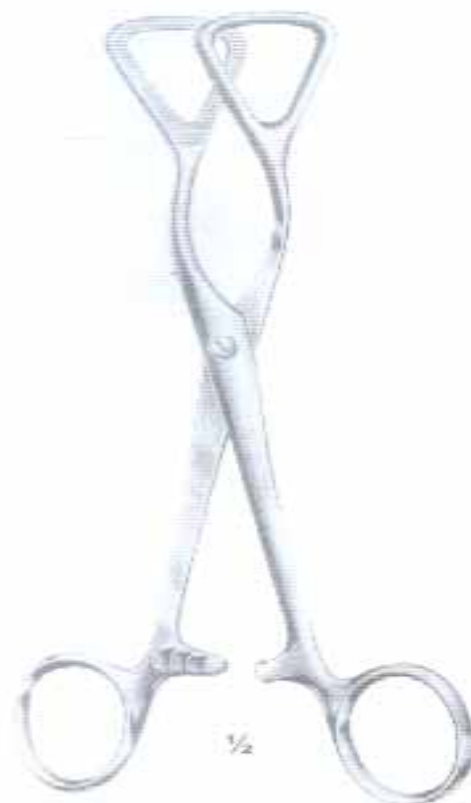

1/2
Guy
72-636
(19cm)



STERILIZING FORCEPS

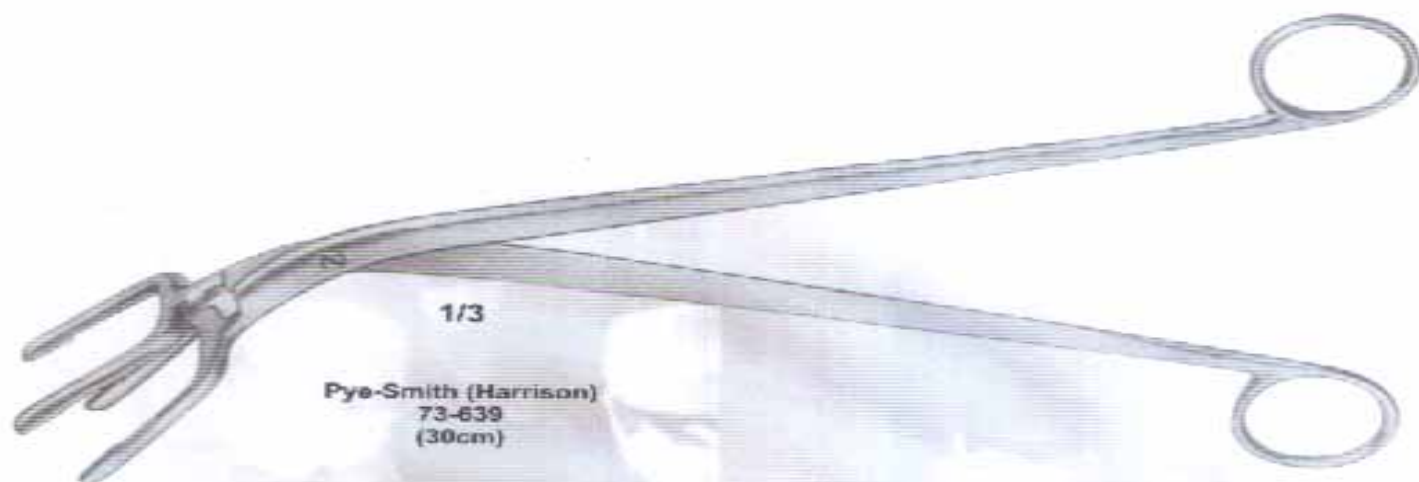

1/3

Pye-Smith (Harrison)
73-639
(30cm)

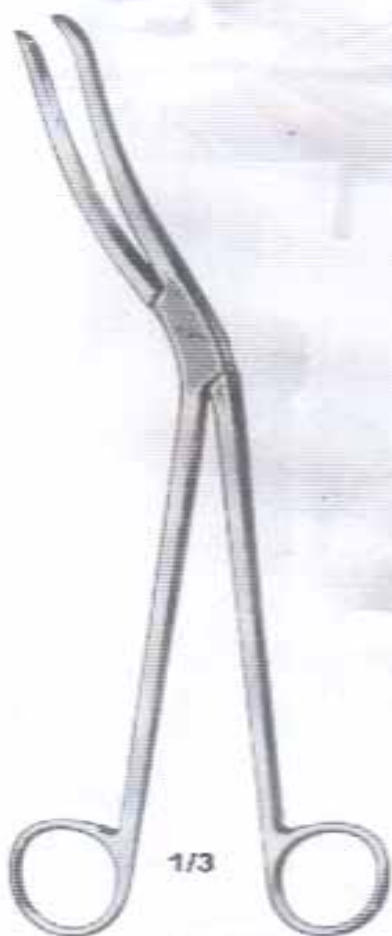

1/3

Cheattle
73-637
(27cm)

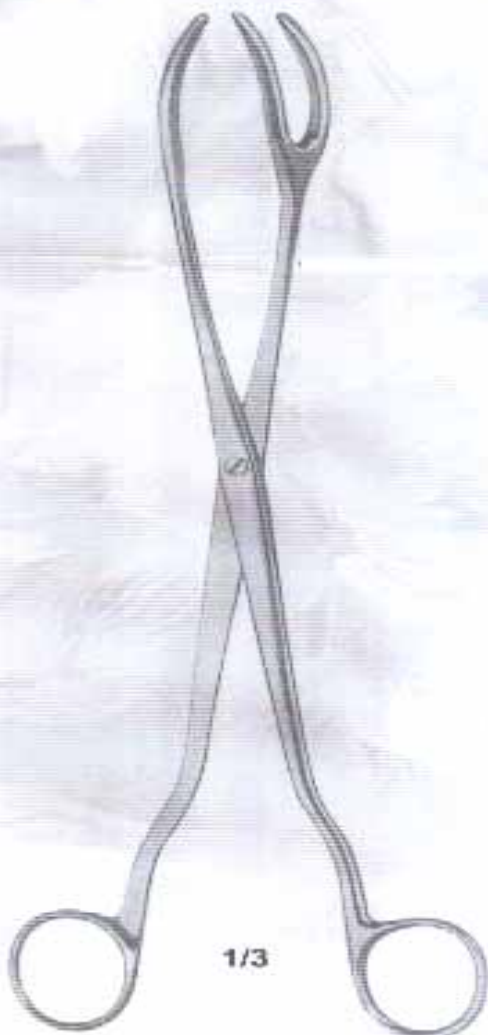

1/3

73-638
(30cm)

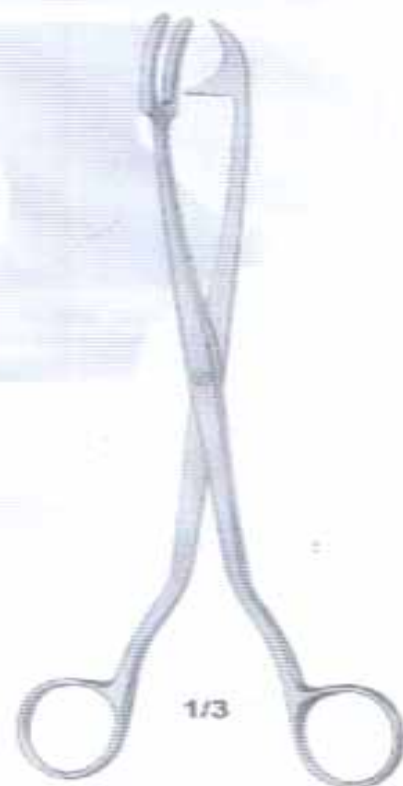

1/3

Rogge
73-640
(23cm)

LARYNGEAL POLYPUS FORCEPS BRONCHO-ESOPHAGOSCOPY FORCEPS

Langen . Lengths . Largos

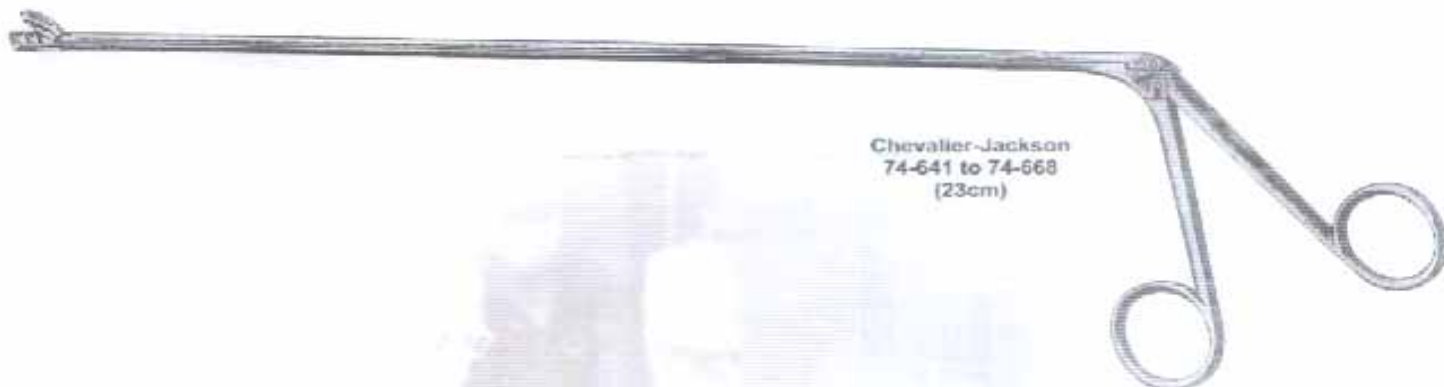

Cm	Inch	74-641	74-645	74-649	74-653	74-657	74-661	74-665
30	12	74-641	74-645	74-649	74-653	74-657	74-661	74-665
40	16	74-642	74-646	74-650	74-654	74-658	74-662	74-666
50	20	74-643	74-647	74-651	74-655	74-659	74-663	74-667
60	24	74-644	74-648	74-652	74-656	74-660	74-664	74-668

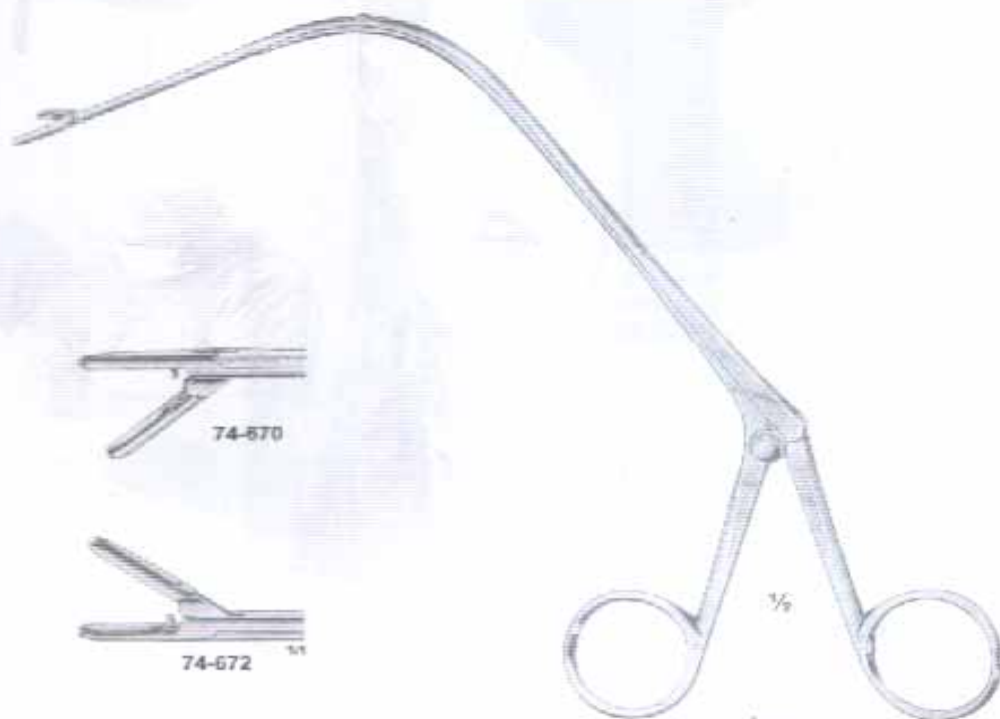

74-669



74-670



74-671



74-672



RHINOPLASTIC INSTRUMENTS



75-673



75-674



75-675



75-677



1/2

Cottle-Walsham
75-673 to 75-675
(23cm)



1/2

Kressner
75-676
(20cm)



1/2

Asch
75-677
(23cm)



RINOPLASTIC INSTRUMENTS



76-678
(2 mm)



76-679
(5 mm)



1/2



76-680
(7 mm)



76-681
(10 mm)



1/2

Fomon
76-682
(16cm)

1/2
Joseph
76-678 to 76-681
(16cm)



1/2

Cottle-Neivert
76-683
(20cm)



1/2



1/2

Cottle
76-684 to 76-686
(15cm)



76-684



76-685



76-686

RHINOPLASTIC INSTRUMENTS



Joseph
77-687
(15cm)



Cottle
77-688
(16cm)



Lange
77-689
(22cm)



77-690
to
77-692
(15cm)



77-690



77-691



77-692



Kilner
77-693
(10cm)



Converse
77-694
(12cm)



Froer
77-695
(15cm)



10



Fomon
77-698
(17cm)



Aufrecht
77-697
(19cm)



10



HOLLOW WARES



78-698
STERILIZING DRUM

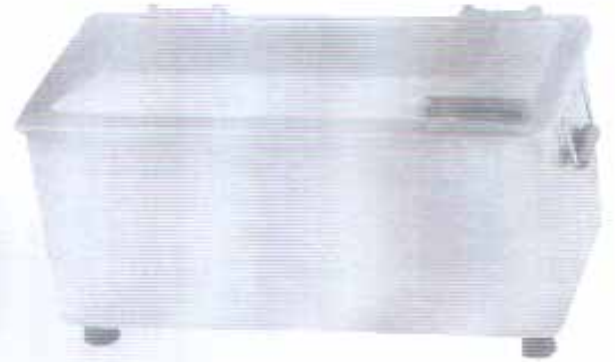

78-699
ELECTRIC STERILIZING



78-700
HORIZONTAL URINAL



78-701
URINAL FEMALE



78-702
PERFECTION BEDPAN



78-703
URINAL MALE



HOLLOW WARES



79-704
KIDNEY TRAY

79-705
FORCEPS JAR



79-706
THERMOMETER JAR



79-707
FEEDING CUP



79-708
DOUCHE CAN / IRRIGATOR



79-709
MEASURING JUG



79-710
ALCOHOL LAMP



79-711
SPUTUM MUG

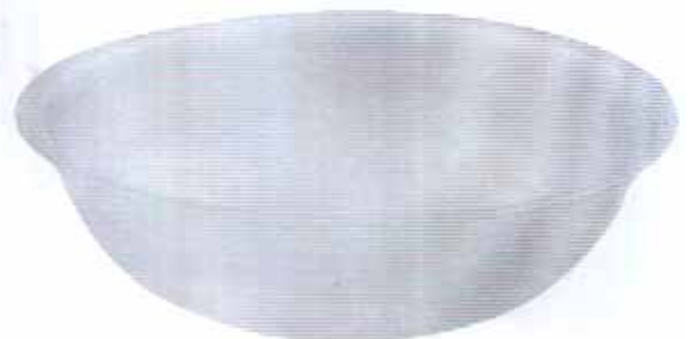

79-712
WASH BASIN



HOLLOW WARES

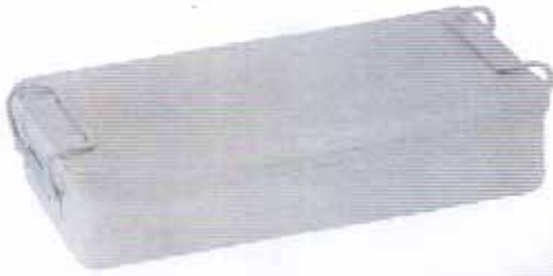

**80-713
BOX WITH LOCK**



**80-714
MESH TRAY**

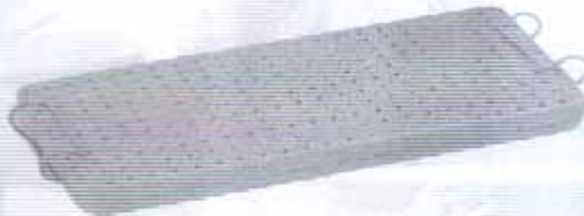

**80-715
INSTRUMENTS BOX**



**80-716
STERILIZER BOX WITH FILTER**



**80-717
INSTRUMENTS STERILIZING BOX**